

Ampron 
COMPOSIT CERAMIC SYSTEM

SWIMMING POOL CATALOG

UNIQUE COMPOSITE CERAMIC POOLS





WELCOME TO AMPRON'S WORLD OF EXPERIENCE

Our customers have been enjoying the comfort and relaxation of our unique composite ceramic pools for more than a decade.

A handwritten signature in blue ink, appearing to read 'Maczkó Tamás', written in a cursive style.

*Tamás Maczkó
Managing director & Owner, founder
IFK-Ampron Ltd.*



QUALITY, RELAXATION, STYLE

A home pool and wellness are essential parts of convenience, relaxation, recharge, and a healthy lifestyle.

The wide range of pools allows you to select the right one that suits your own individuality, lifestyle, and the features of your real estate.

Ceramic technology is the key to quality and carefree long-term use. Prefabricated pools can be installed in a few days and enjoyed for decades!

Ampron has been manufacturing and selling fiberglass plastic pools since 1994. In the manufacturing of Ampron Composite Ceramic System swimming and wellness pools the highest quality materials, specially developed for this purpose, are being used, which meet high chemical and physical requirements to guarantee the endurance and long life of the pool.

Ampron 
COMPOSIT CERAMIC SYSTEM

AMPRON CERAMIC SYSTEM

20 YEARS WARRANTY

The pool construction method of the 9-layer fiberglass Ampron Composite Ceramic System technology and stratified structure guarantees high strength, beautiful brilliant surface, outstanding longevity, low maintenance and repair costs to our pools, all of which add to a long-term carefree use! All our pools can be equipped with a hydrostatic valve at the deepest point of the pool, which particularly provides protection against high groundwater pressure.

Warranty for the framed structure and the watertightness of the pools is 20 years. Warranty begins upon the installation of the pool, provided the installation is conducted by a contracted partner of IFK-Ampron Ltd. and in accordance with the installation instructions. Warranty does not apply in any other cases.

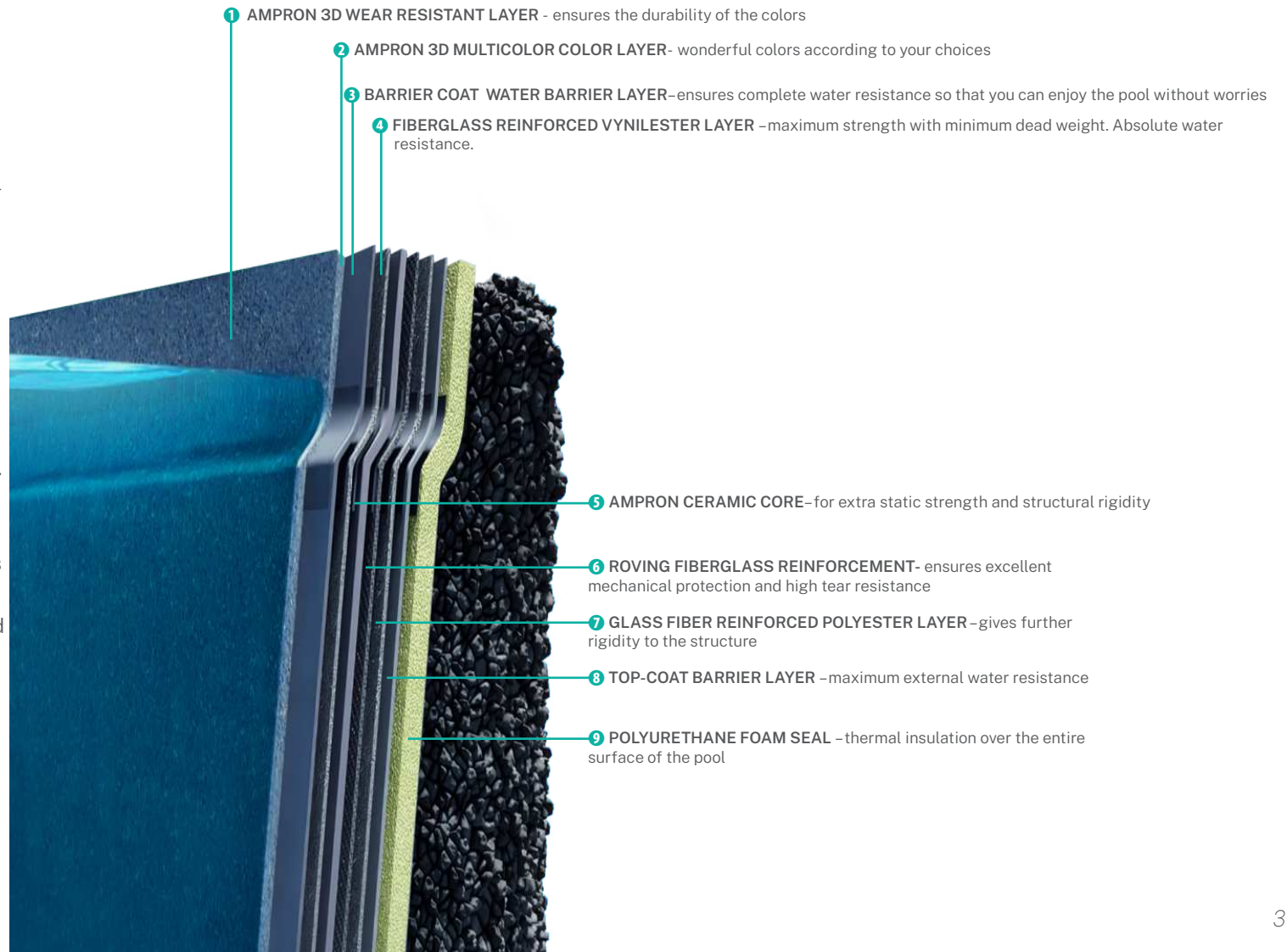

COMPOSITE CERAMIC POOLS

SPA 220



L W D
2,2 x 2,2 x 1 m

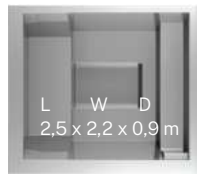

L W D
2,5 x 2,2 x 0,9 m

SPA 250

KORFU

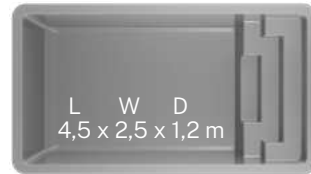

L W D
4,5 x 2,5 x 1,2 m

WELLNESS

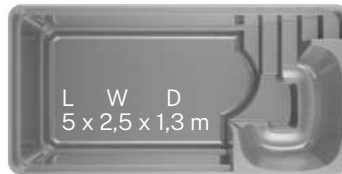

L W D
5 x 2,5 x 1,3 m

TOSCANA



L W D
6 x 3 x 1,4 m

IBIZA



L W D
6,5 x 3,5 x 1,5 m

RIMINI 6



L W D
5,6 x 2,7 x 1,4 m

RIMINI 7



L W D
7 x 3,5 x 1,5 m

RIMINI 8



L W D
8 x 3,8 x 1,5 m

ROMA 65

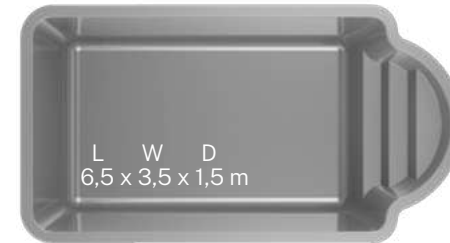

L W D
6,5 x 3,5 x 1,5 m

ROMA 90



L W D
9 x 3,75 x 1,5 m

ADRIA 75



L W D
7,5 x 3,8 x 1,5 m

ADRIA 100

L W D
10 x 3,8 x 1,5 m



SPA 62

L W D
6,2 x 3,75 x 1,5 m

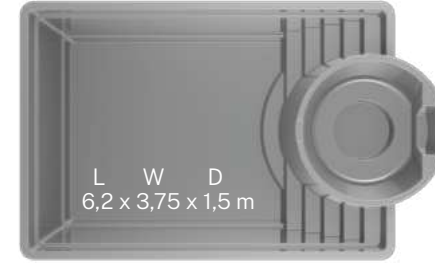

L-Length
W-Width
D-Depth

GENOVA 70

L W D
7 x 3,8 x 1,5 m

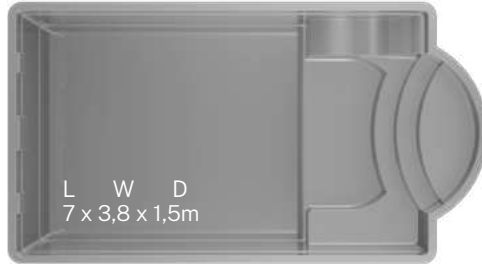

SPA 92

L W D
9,2 x 3,75 x 1,5 m

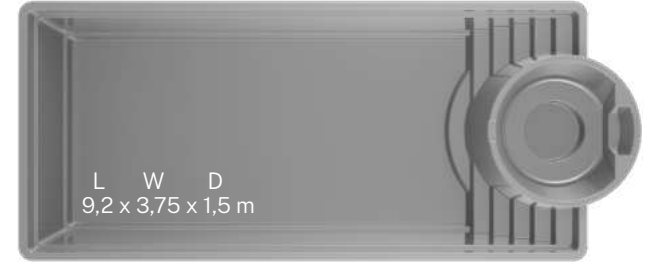

GENOVA 90

L W D
9 x 3,8 x 1,5 m



SPA MINIMAL

L W D
10 x 3,8 x 1,5 m



CAPRI

L W D
8 x 3,8 x 1,5 m

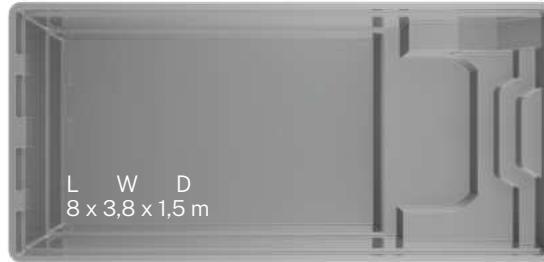

MIAMI

L W D
10 x 3,8 x 1,5 m



ISTRIA

L W D
11 x 3 x 1,5 m



OVERFLOW



UNIQUE 3D COLORS

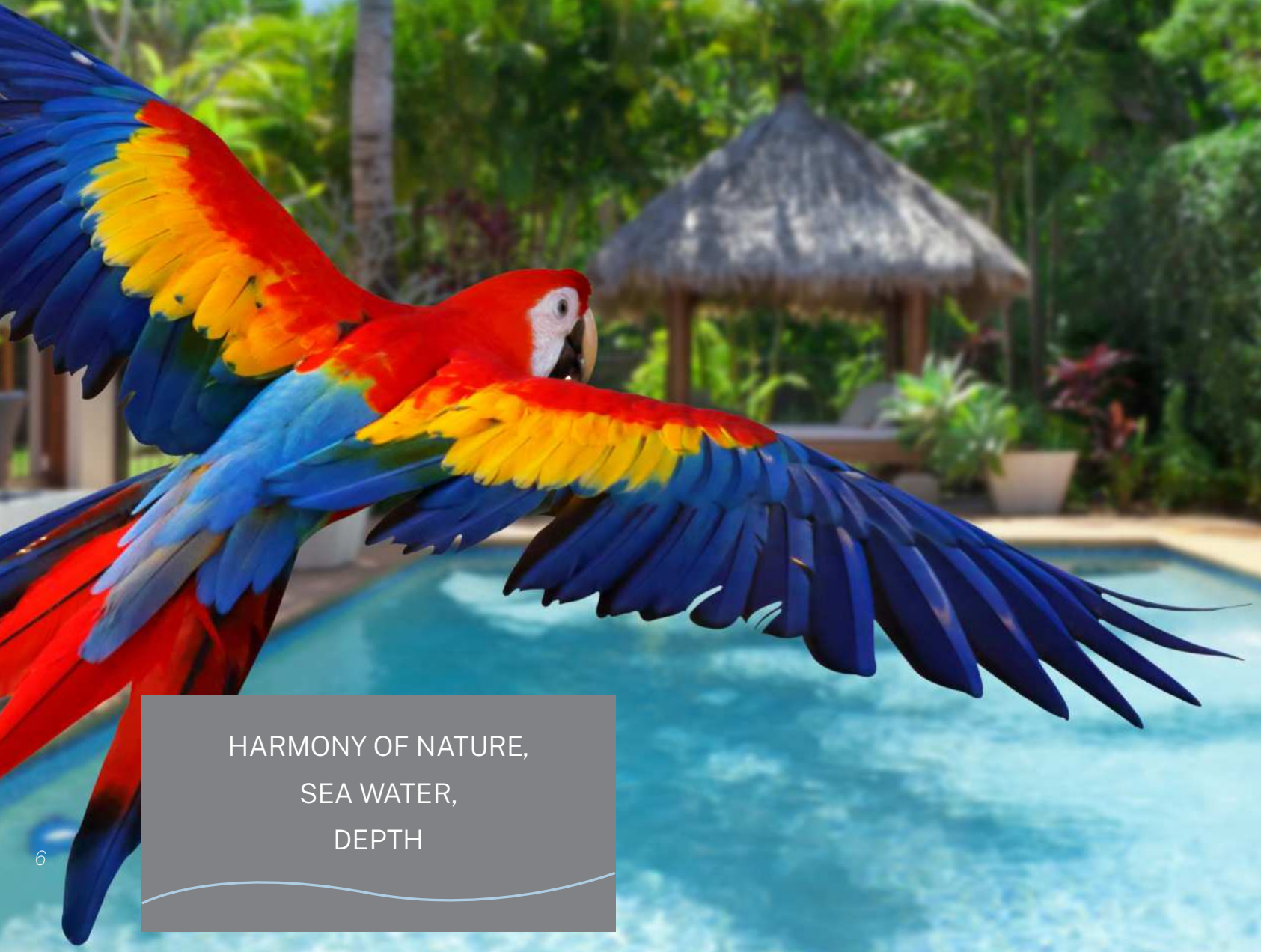

HARMONY OF NATURE,
SEA WATER,
DEPTH

The pool water reflects three different natural effects because of the color scheme of our pools.

BASE COLORS: Completely smooth, non-glitter colors that reflect the “clear water” effect of natural waters

BRILLANT COLORS: Glittery colors that generate the effect of “sea water” and a sparkling water surface

AMPRON 3D MULTICOLOR COLORS: Glittery colors, more vivid than brilliant colors that reflect a sparkling and “deep water” effect

BASE COLORS

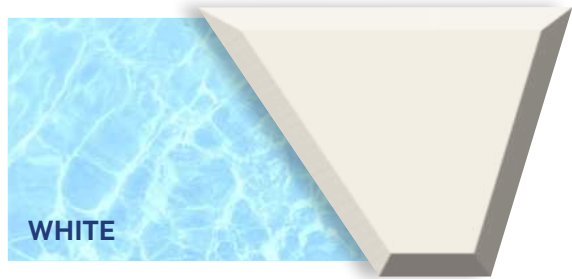

BRILLANT COLORS



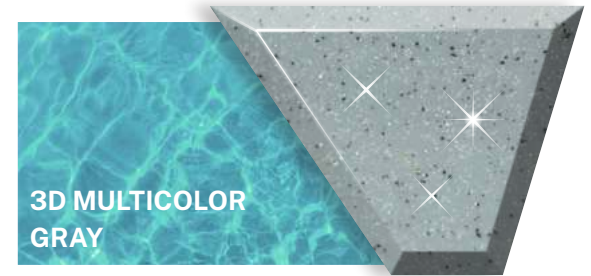

3D MULTICOLOR COLORS



OVERFLOW WATER

ACTIVE RELAXATION

 OVERFLOW WATER SURFACE

 3D MULTICOLOR BLUE

 GRES CURB

 GRES STONE



When installing a pool, one of the first issues to decide is usually the type of the recirculation system available, namely should it be the skimmer / infinity system.

In general, it impacts the structure and type of finish used around the pool.

OVERFLOW WATER SURFACE

The water falls over the rim into the drainage channel, thus eliminating rebound waves on the surface, which significantly increases the comfort of swimming and bathing. The elegant appearance of the stretched water ensures the harmony of the pool and its surroundings.



↑  OVERFLOW WATER SURFACE
 GRES STONE

Floor diffusers flow water upward in the pool which then flows over the rim into a buffer tank via an overflow trough at the edge of the pool. From here, the water is sucked by the rotary pump and then pushed through the filter cartridge to return to the pool.

There are no dead spaces in an infinity pool and the filtration is perfect.

INFINITY

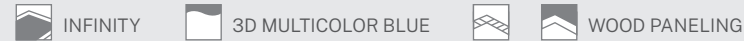
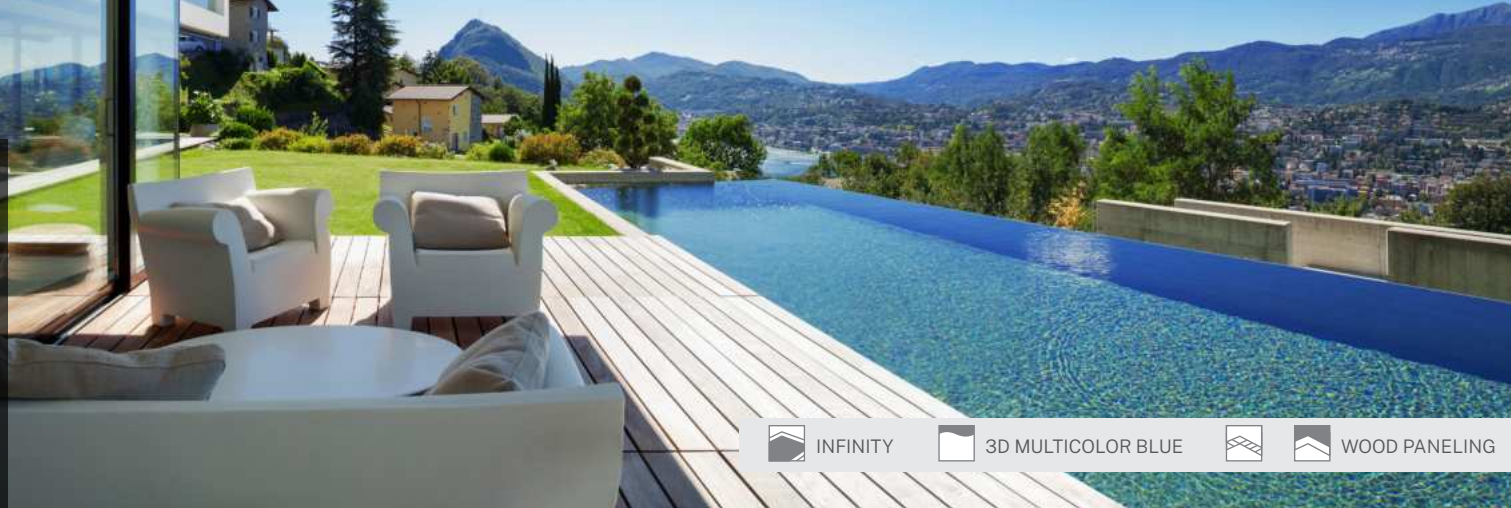

INFINITY - also known as the „Finnish“ circulation system

“Infinity” is the name given to systems that allow water to overflow at the top of the pool, where it is collected in a conduit and then filtered through a more complex, structured system. Infinity looks more impressive than a skimmer system and its surroundings are completely levelled to the water surface, the pool looks to be the continuation of the “shoreline”.

Infinity and skimmer systems differ from each other quite extensively both technically and for their visual effect.

Any types of our pools can be installed with the infinity system, which is one of the most modern solutions and there are several versions of it.

You can choose between all types of overflow water surface pools, which are among the most modern, and there are also several versions of them.



OVERFLOW SKIMMER

It is used in non-overflow water pools in which the water surface is 5-10 cm below the edge of the pool and the filtration system is less complex. The skimmer system is used to remove dirt on the water surface, and it is a more traditional type of filter that is easier to install and consequently less expensive.

KORFU

The smallest one of our pool range. An ideal choice for smaller or narrower spaces; feasible on a smaller budget due to its size. The steps serve as a comfortable seat and can be equipped with optional massage elements, which enhance relaxation. The installation of a counter-current system makes it suitable for swimming despite the small size of the pool.

COMPACT
COMFORT

10



WHITE



GRES STONE

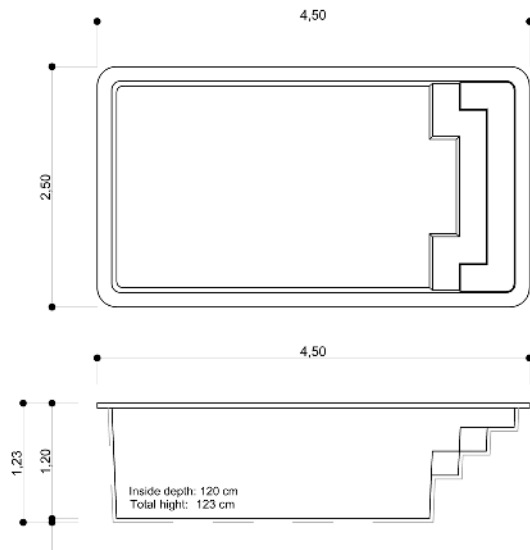

Length	4,5 m
Width	2,5 m
Depth	1,2 m
Volume	9 m ³



WELLNESS

This pool is a combination of functionality and practicality. The high-performance counter-current system makes it an excellent sports pool for swimming or wellness bathing. The seating area, an integrated massage zone ensures perfect relaxation for the body. This pool is really a spa jacuzzi and a swimming pool in one.

SWIM-SPA JACUZZI &
POOL IN ONE

 3D MULTICOLOR BLUE



 GRES COVER

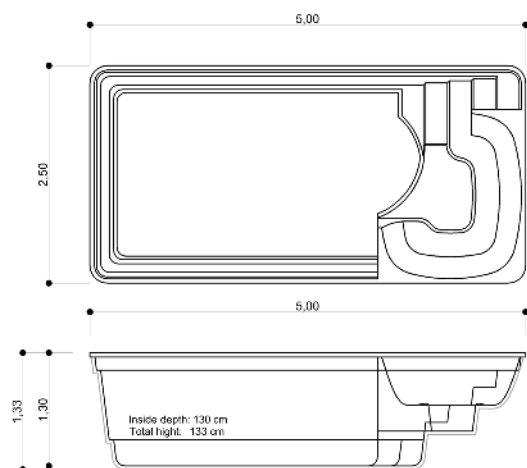

Lenght	5,0 m
Width	2,5 m
Depth	1,3 m
Volume	11 m ³

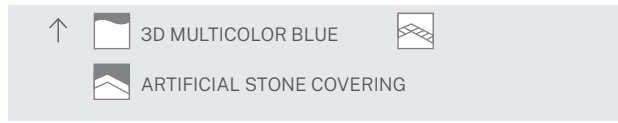
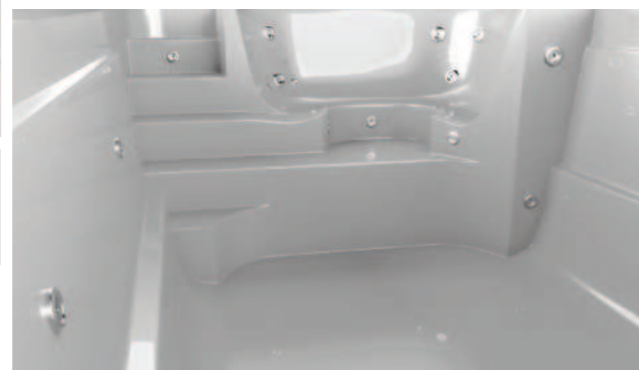
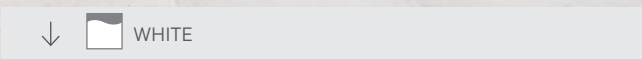

TOSCANA

The sleek oval shape and the seating and relaxation area at the end of the pool make Toscana a truly multifunctional pool.

An ideal home pool, the designed seating can comfortably accommodate up to 2 people and you can enjoy the optional air or water massage functions. The 3D multicolor beige color, reminiscent of beach sand, highlights the pool from its surroundings, making its oval shape cozy.

SIMPLICITY,
MULTIFUNCTIONALITY



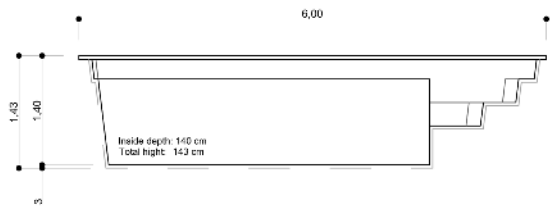
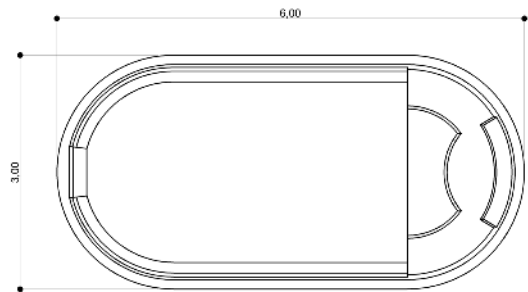

Length	6,0 m
Width	3,0 m
Depth	1,4 m
Volume	17 m ³



↑
3D MULTICOLOR BEIGE
BLOCK STONE COVERING

↓
LIGHT BLUE
ARTIFICIAL STONE CURB
BLOCK STONE COVERING



IBIZA

MAXIMUM
SWIMMING

 LIGHT BLUE



 GRES WOOD PANELING

Straight, clean shape. The narrow steps provide maximum space utilization for the swimming zone.

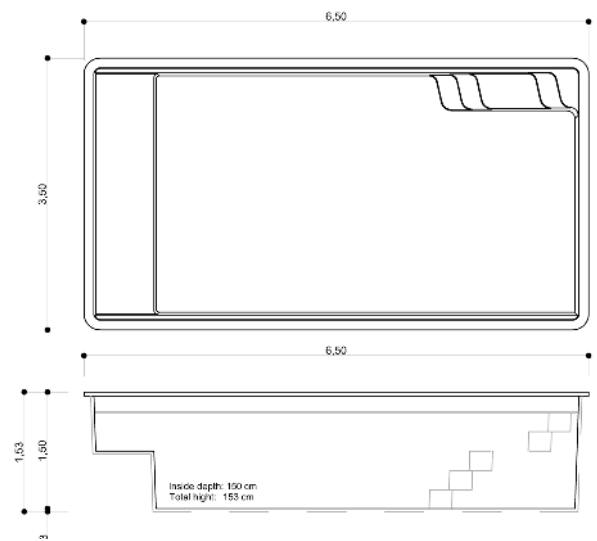

Length	6,5 m
Width	3,5 m
Depth	1,5 m
Volume	27 m ³



↑
 3D MULTICOLOR BLUE
 GRES COVER

↓
 3D MULTICOLOR BLUE
 DECOR CONCRETE COVERING



RIMINI

MAXIMUM SWIMMING

The size range of the Rimini pool family makes it an excellent choice for both outdoor and indoor installation. Its sleek, simple shape makes installation quite easy. Not only do the non-slip steps increase safety, but the comfortable seating bench at the middle step allows an easy installation of wellness functions to increase relaxation impact. The optional counter-current system makes Rimini an excellent pool for swimming and sports.

 3D MULTICOLOR BEIGE

 GRES CURB

 GRES COVER

RIMINI



3D MULTICOLOR BEIGE



GRES CURB



GRES STONE

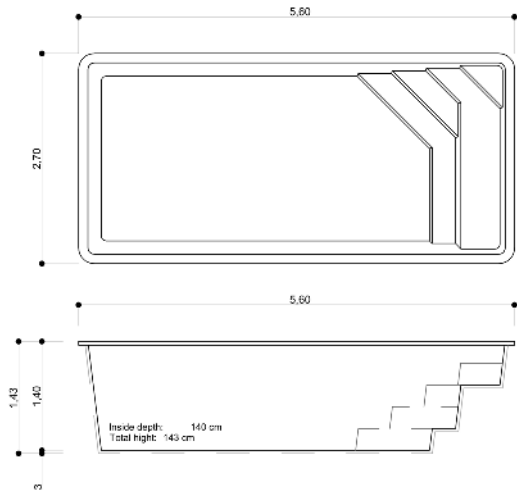

Lenght	5,6 m
Width	2,7 m
Depth	1,4 m
Volume	16 m ³

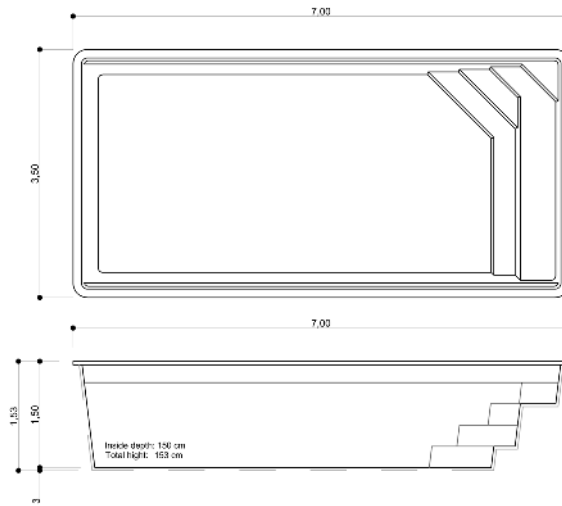

Lenght	7,0 m
Width	3,5 m
Depth	1,5 m
Volume	29 m ³

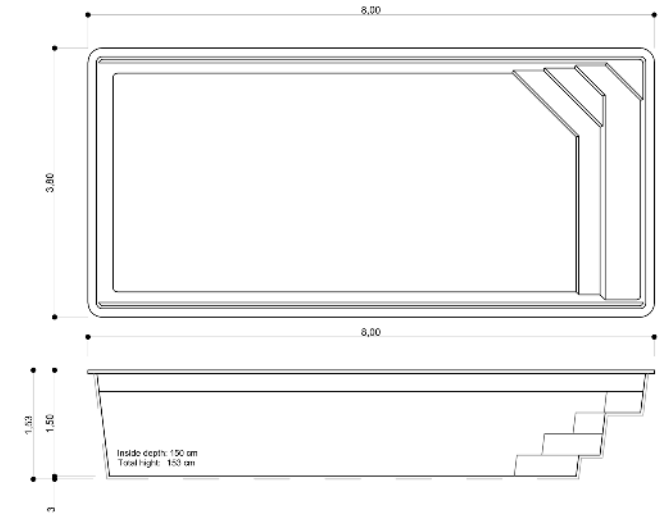

Lenght	8,0 m
Width	3,8 m
Depth	1,5 m
Volume	37 m ³

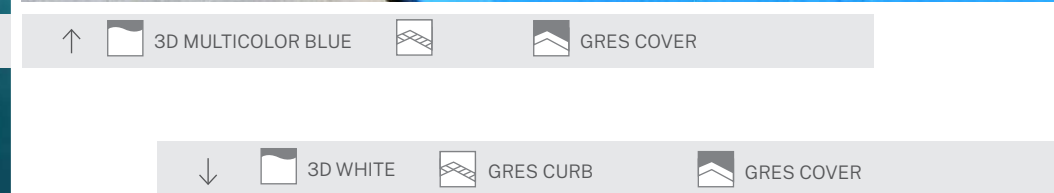
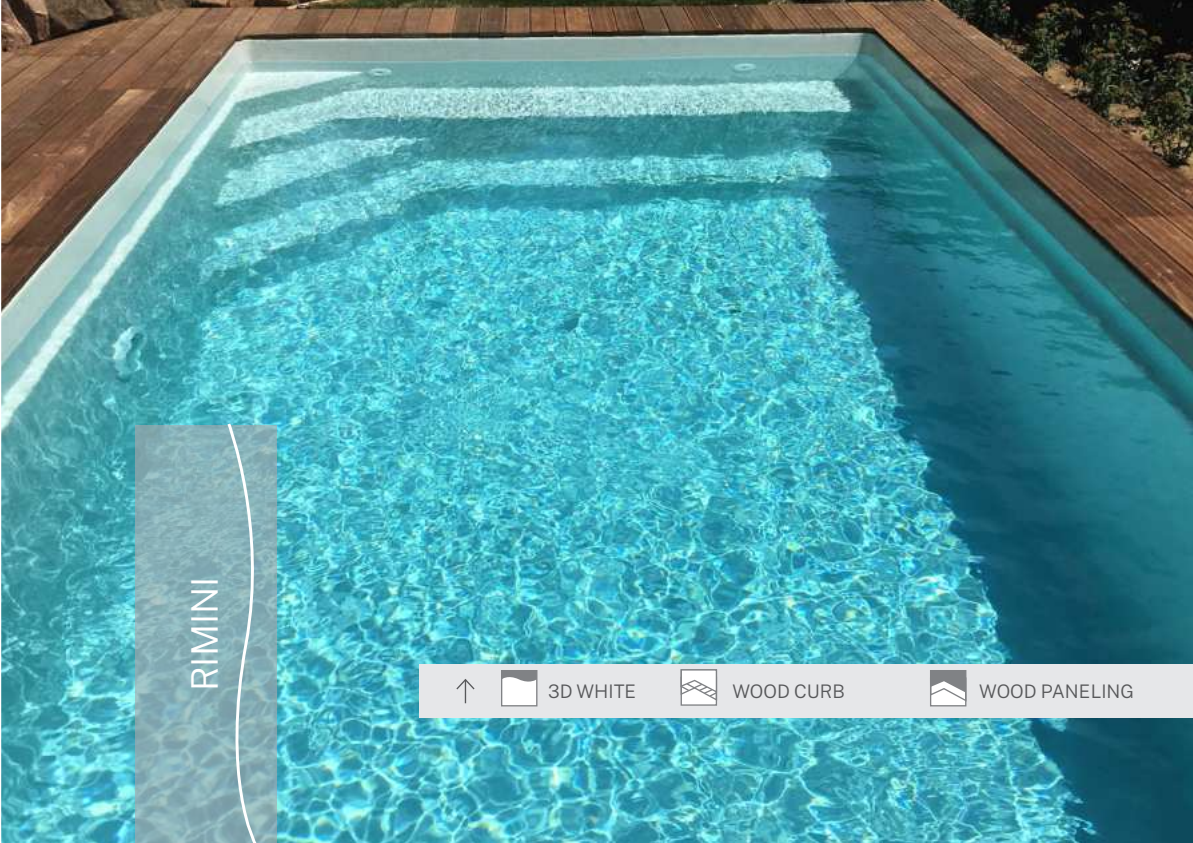

ROMA

The Roman-style steps make this pool an eternal classic and forever-fashionable shape that fits elegantly any environment. Clean, straight lines and large arcs make it unique. Large non-slip steps ensure safety. The large size makes it an excellent choice for families or for particularly large spaces.

ETERNAL DESIGN



WHITE



GRES CURB



GRES COVER



ROMA



BRILLANT HAWAII SAND



ARTIFICIAL STONE CURB



WOOD PANELING

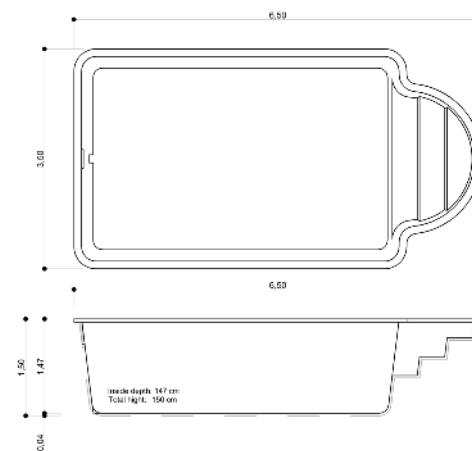

Lenght	6,5 m
Width	3,5 m
Depth	1,5 m
Volume	22 m ³

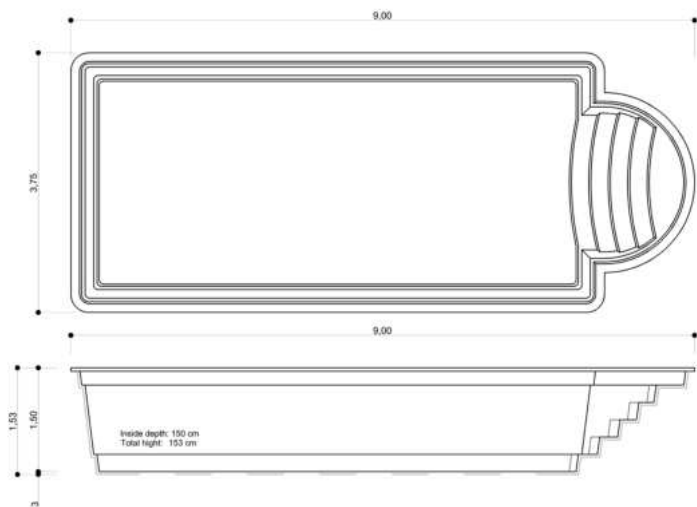

Lenght	9,0 m
Width	3,75 m
Depth	1,5 m
Volume	39 m ³



↑ WHITE GRES COVER

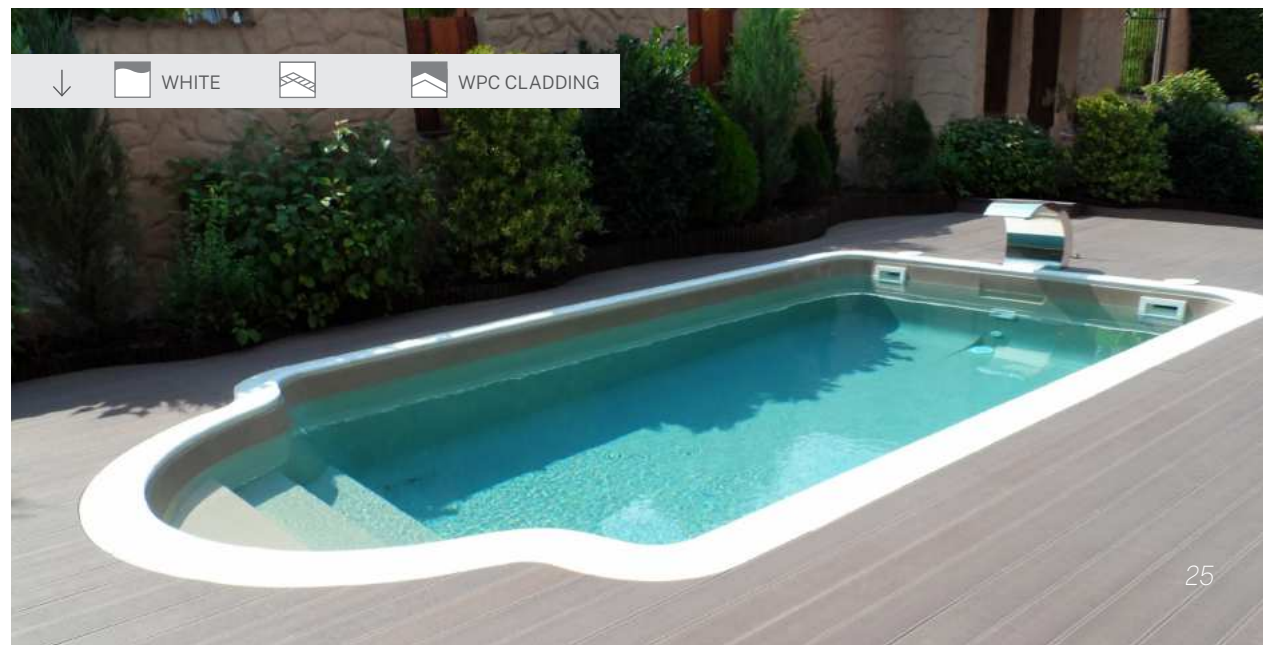

↓ WHITE WPC CLADDING

ADRIA

This pool is clearly about size and dimensions. The Adriatic 100 is our largest pool with its clear shape and straight lines and both the swimming zone, and the seating steps are huge. The safe, non-slip and comfortable seating bench in the middle of the steps allows you to install up to 6 hydromassage and 10 air massage jets. The pool provides an impressive wellness experience both indoors and outdoors.

NO COMPROMISE



↑  3D MULTICOLOR WHITE  GRES COVER

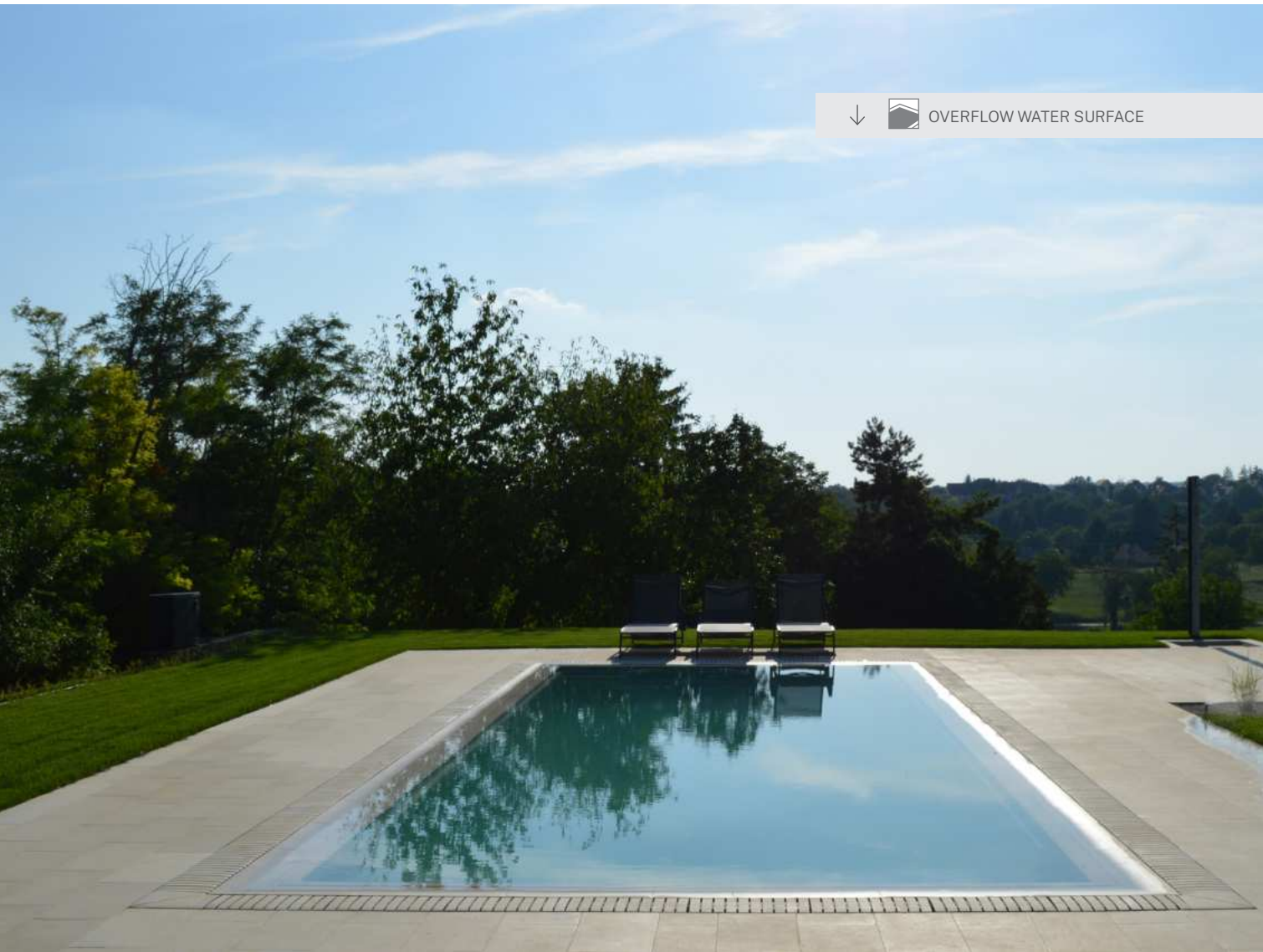

↓  OVERFLOW WATER SURFACE

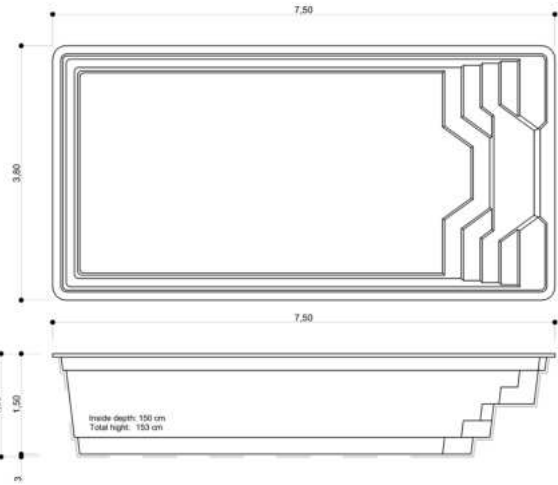

Lenght	7,5 m
Width	3,8 m
Depth	1,5 m
Volume	32 m ³

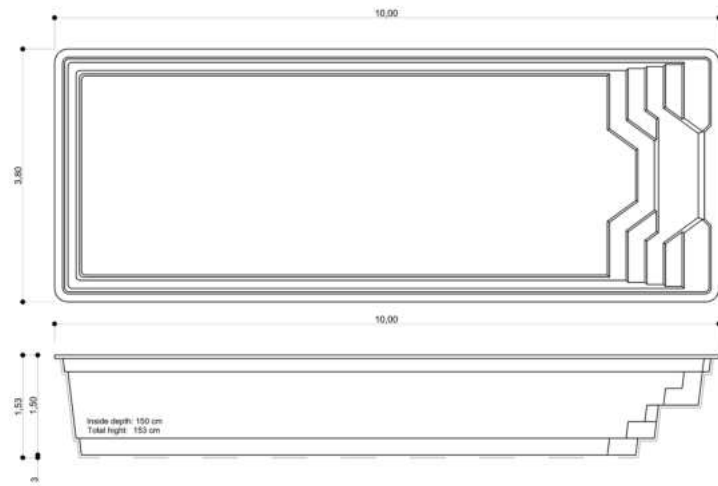

Lenght	10,0 m
Width	3,8 m
Depth	1,5 m
Volume	45 m ³



↓ 3D MULTICOLOR BLUE GRES CURB GRES COVER



↑ 3D MULTICOLOR WHITE GRES CURB GRES COVER



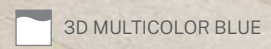
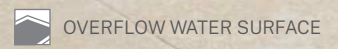

GENOVA

The 80 cm deep front of the pool allows children to paddle cheerfully while adults swim and bathe in the 150 cm back of the pool. The large seating area is perfect for a massage with relaxing and pampering functions. Its size, versatility, and functionality, makes it an ideal choice for families, wellness, and relaxation enthusiasts.

VERSATILITY BEYOND ANYTHING





-   OVERFLOW WATER SURFACE
-  3D MULTICOLOR WHITE
-  GRES CURB
-  GRES COVER



 OVERFLOW WATER SURFACE

 3D MULTICOLOR BLUE

 GRES CURB

 GRES COVER

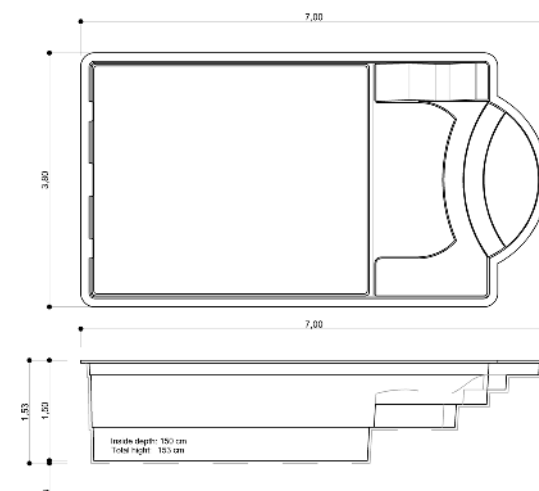

Length	7,0 m
Width	3,8 m
Depth	1-1,5 m
Volume	25 m ³

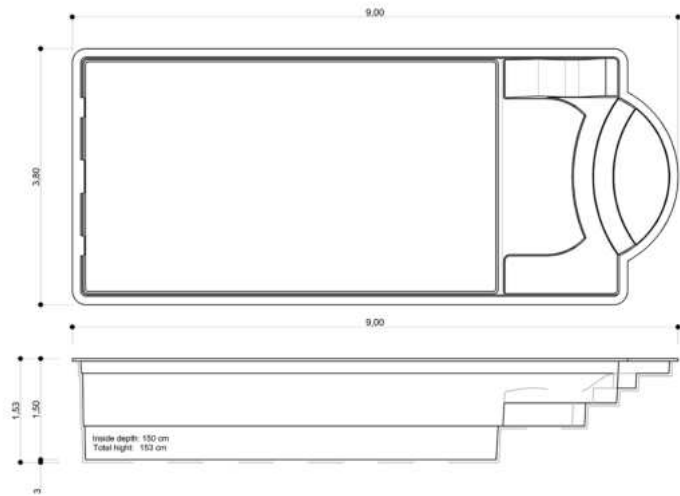

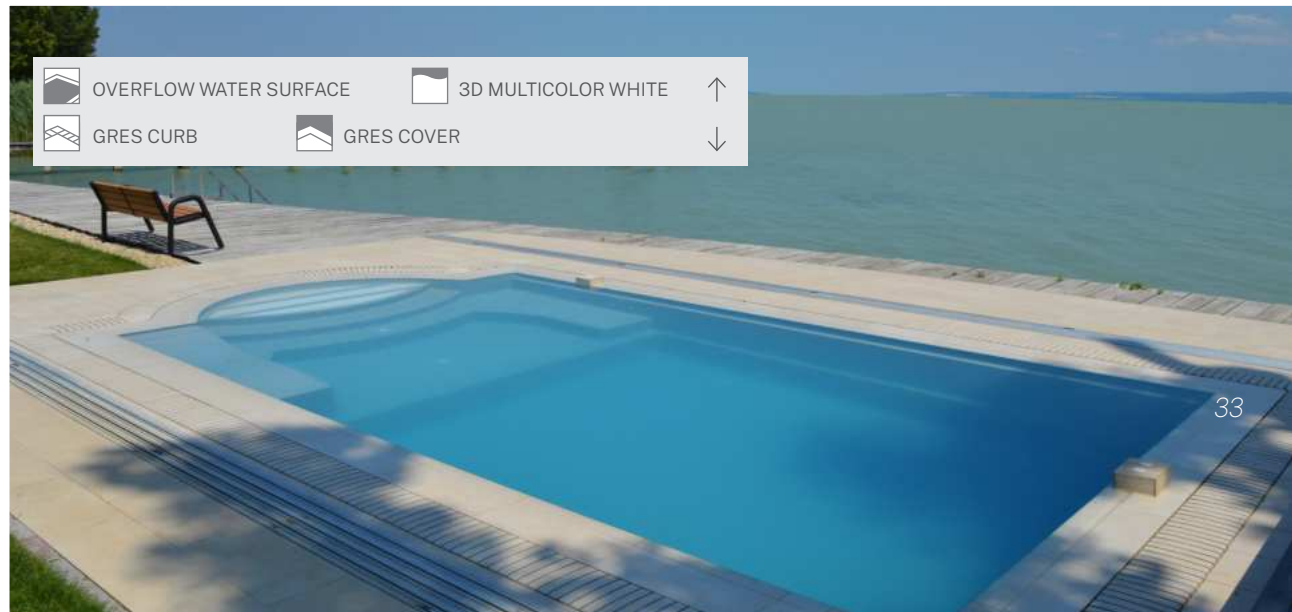

Length	9,0 m
Width	3,8 m
Depth	1-1,5 m
Volume	35 m ³



	OVERFLOW WATER SURFACE		3D MULTICOLOR WHITE	↑
	GRES CURB		GRES COVER	↓

MIAMI

MAXIMUM SPACE

-  3D MULTICOLOR BEIGE
-  GRES CURB
-  GRES COVER

Classic elegance, straight lines and maximum use of space characterize this pool, which, due to its minimalist style stands out in all environments. Because of its large size, it provides an extremely imposing look, an ideal choice for families or those with a particularly large space.

Safe access is ensured by the straight, non-slip stairs running the full width of the pool, which also serves as a comfortable wide seating bench.

A counter-current device can be selected as an additional accessory, with which we can enhance the experience of active recreation.

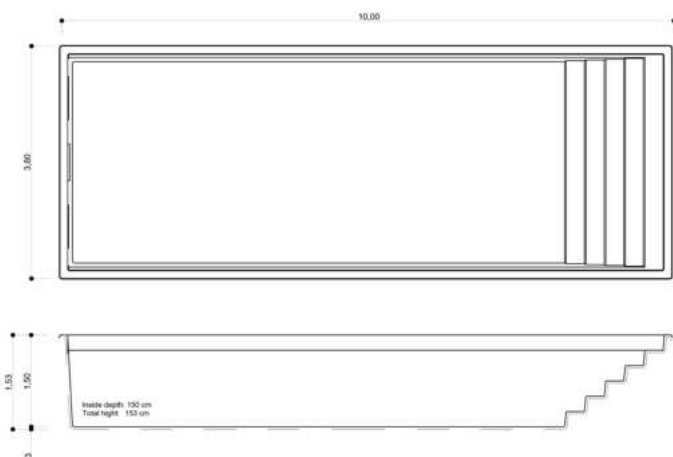

Lenght	10,0 m
Width	3,8 m
Depth	1,5 m
Volume	46 m ³



↑ 3D MULTICOLOR BEIGE GRES CURB GRES COVER

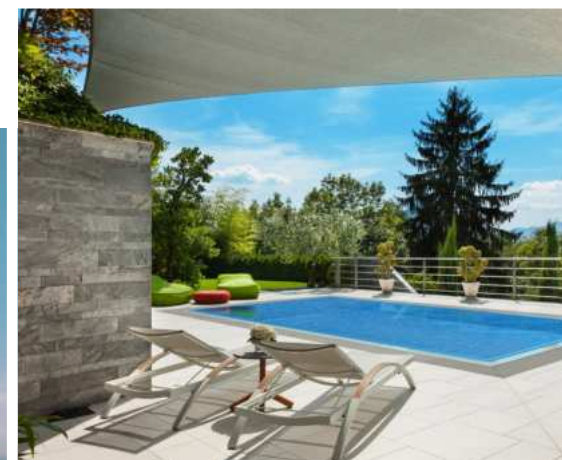

↑ 3D MULTICOLOR BLUE GRES CURB GRES COVER



↑ 3D MULTICOLOR BEIGE GRES CURB GRES COVER

SPA

JACUZZI & POOL

Jacuzzi and pool in one - the perfect choice for those who want to relax and bathe at the same time. You can enjoy both the convenience of swimming pools and spas.

The water temperature is different in the completely separate pool zones, each with their water engineering systems. The jacuzzi can be used at 32-36 C and the swimming pool at 27-28 C at the same time. The massage pool can operate economically all year round, separated from the swimming pool zone.



- ↑  3D MULTICOLOR GRAY
-  GRES CURB
-  GRES COVER



↓
3D MULTICOLOR GRAY
GRES CURB
GRES COVER

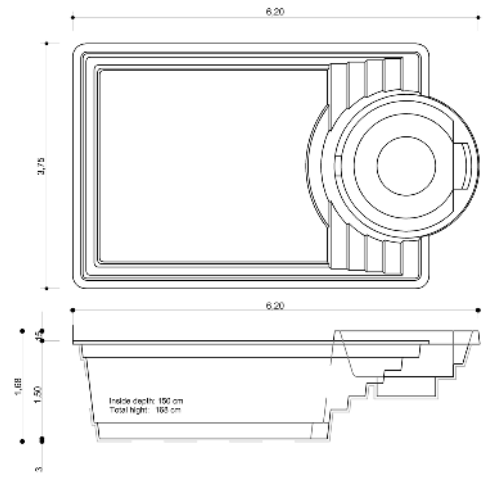

Length	6,2 m
Width	3,75 m
Depth	1,5 m
Volume	21 m ³

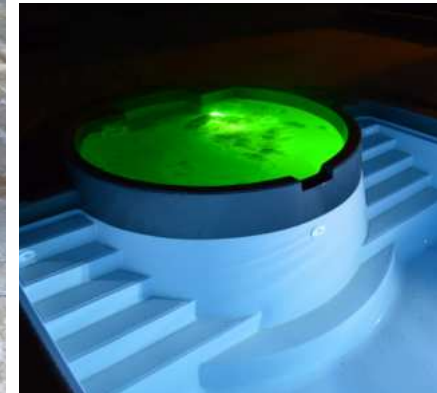
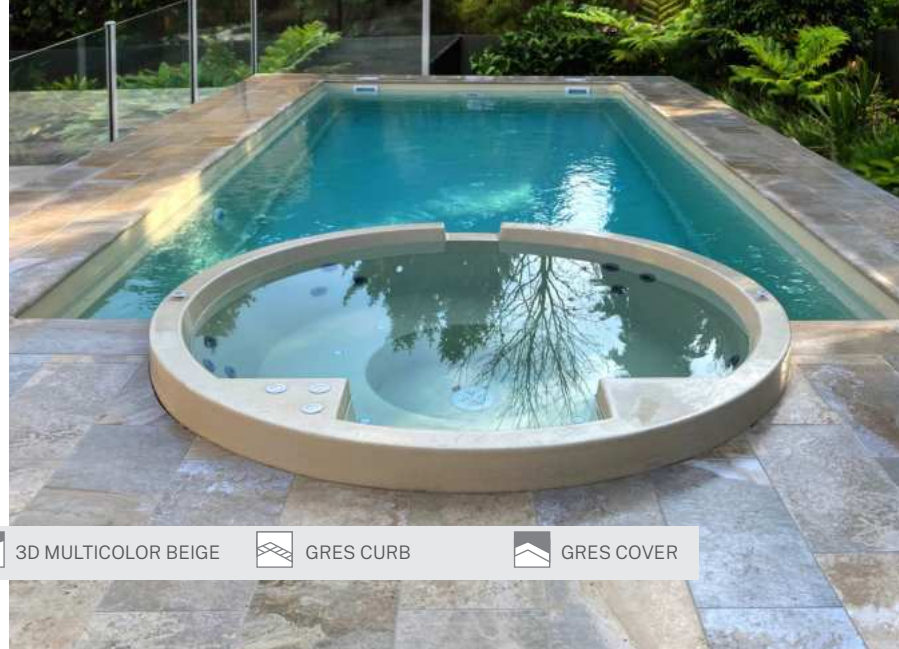
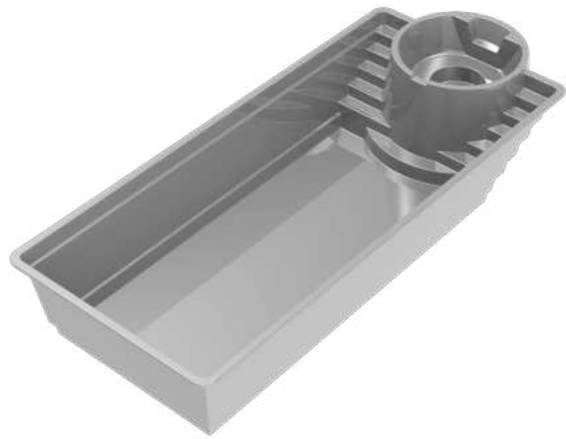

↗  3D MULTICOLOR BEIGE  GRES CURB  GRES COVER

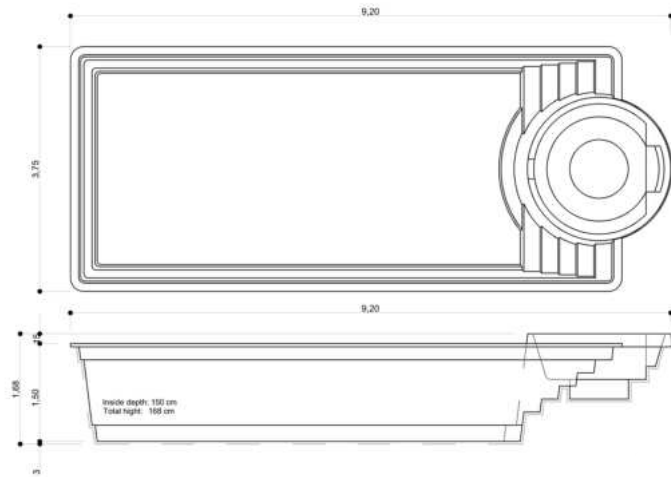

Length	9,2 m
Width	3,75 m
Depth	1,5 m
Volume	40 m ³

↓  3D MULTICOLOR GRAY  GRES CURB  GRES COVER



SPA MINIMAL

Clean and unique shape. Jacuzzi and pool in one - the perfect choice for those who want to relax and rest in addition to bathing. You can enjoy both the convenience of massage pools and swimming all at the same time.

The two zones of the pool are completely separate with their own water engineering systems, so the water temperature is different in each zone. The jacuzzi can be used at 32-36 C and the pool at 27-28 C at the same time for bathing. The square shaped massage pool can be operated economically all year round, separately from the pool zone.

JACUZZI & POOL IN ONE



3D MULTICOLOR WHITE



MARBLE CURB



MARBLE COVERING

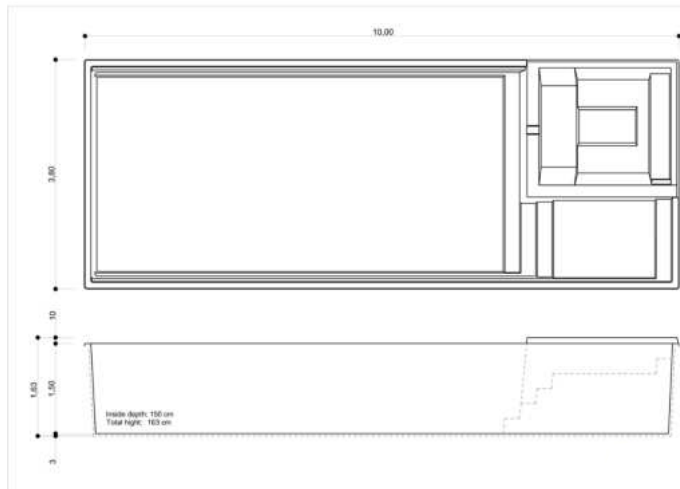

Length	10 m
Width	3,8 m
Depth	1,5 m
Volume	42 m ³

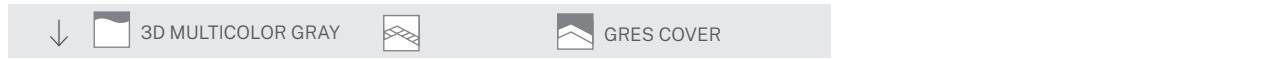
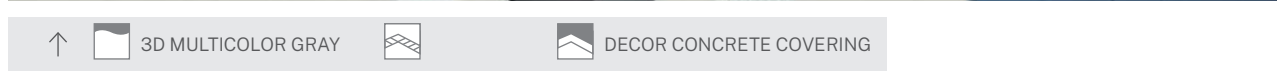

CAPRI

Dank der geraden Linien ist die Größe des Schwimmbereichs maximal. Die ganze Familie kann darin bequem entspannen. Die unterschiedlichen Wassertiefen des Beckens ermöglichen es kleinen Kindern und Erwachsenen gleichermaßen, das Baden in Gesellschaft zu genießen.

FAMILY ADVENTURE POOL

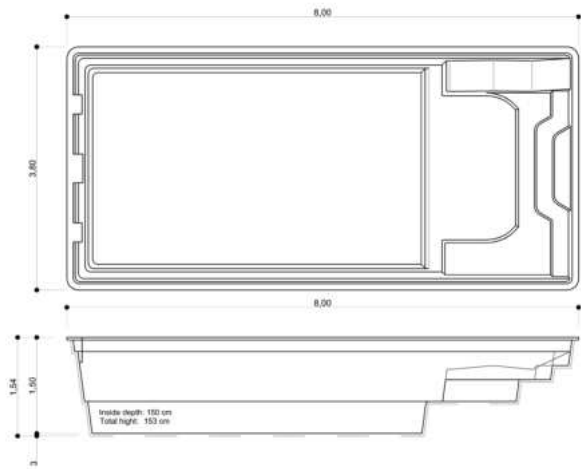

Length	8,0 m
Width	3,8 m
Depth	1,5 m
Volume	31 m ³



↑ 3D MULTICOLOR WHITE GRES CURB GRES COVER

↓ 3D MULTICOLOR BEIGE GRES CURB GRES COVER



ISTRIA

This pool is the ideal choice for those who want to actively relax and swim regularly. The narrow steps contribute to enhance the swimming experience while allowing optimal space utilization. An optional counter-current device can be added to increase the intensity of athletic swimming.

ACTIVE RELAXATION



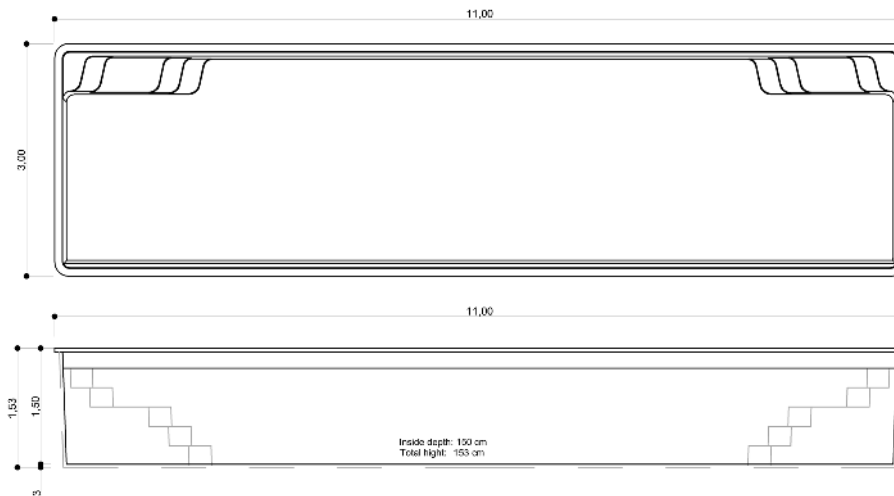
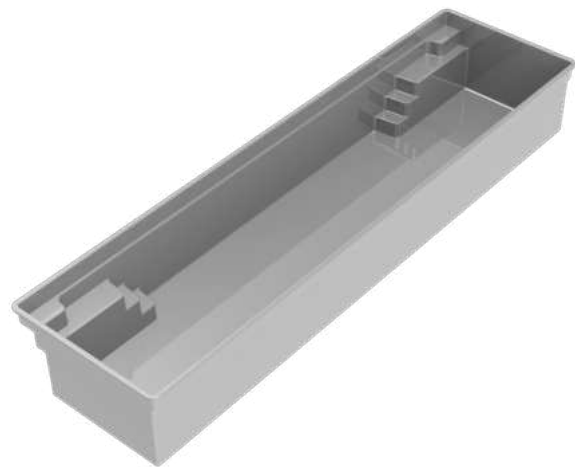
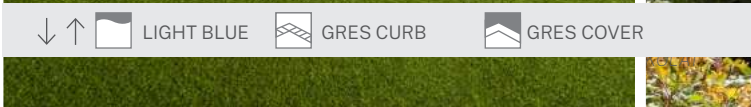

Lenght	11,0 m
Width	3,0 m
Depth	1,5 m
Volume	41 m ³

SPA 250

The Spa pool's angular design is an elegant addition to any environment, both indoors and outdoors. This pool is the ideal choice for those who love wellness and relaxation. The massage pool can comfortably accommodate 4 people, while air and water massage jets ensure total relaxation.

WELLNESS EXPERIENCE



3D MULTICOLOR GRAY



GRES COVER

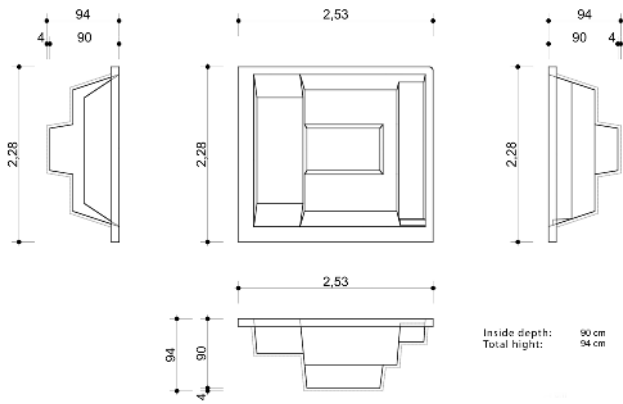

Length	2,53 m
Width	2,28 m
Depth	0,9 m
Volume	2 m ³



SPA 220

Time spent in the Spa Jacuzzi is a real recharging experience for those looking for relaxation. Designed for 4 people, the pool can be installed both indoors and outdoors, allowing you to experience the spa experience from the comfort of your own home.

JACUZZI POOL

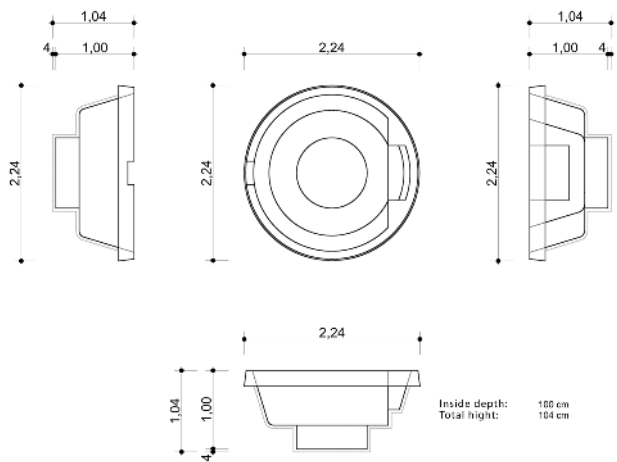

Lenght	2,24 m
Width	2,24 m
Depth	1 m
Volume	1,5 m ³



↑
3D MULTICOLOR BLUE
WOOD PANELING



AESTHETICS - FUNCTIONALITY - PRACTICALITY

UNCOMPROMISING
QUALITY

The aesthetics of the space surrounding the pool are accentuated by the edging and cladding. However, the edging and cladding must have a number of functional and practical property.

POOL STONES

- give a strong hold to the pool
- frame the edge of the pool, close the junction of the walkway and the pool
- waterproof insulation
- minimize the ingress of dirt into the water
- act as a breakwater so less water escapes from the pool

WALKING PAVEMENT

- it must look and feel pleasant and natural because we often walk barefoot on it
- be non-slip for safety
- the surface must be easy to clean to prevent bacteria from settling to avoid infections or unpleasant odors
- withstand the weather: do not stain, moss, mold over time, be frost-resistant
- be easy to care for



First of all, our finishes are extremely aesthetic and not only meet functional and practical aspects but are available in a wide range. We offer four types of them.



CURBSTONE

It perfectly covers the gap between the pool and the walking surface, gives an aesthetic frame to the pool, emphasizes its outline. We offer custom pool stones in a variety of colors, size and materials to match the curves of our pools. Our range is available in

- smooth or rounded pool curbs - typically for skimmer pools
- square, traditional rim

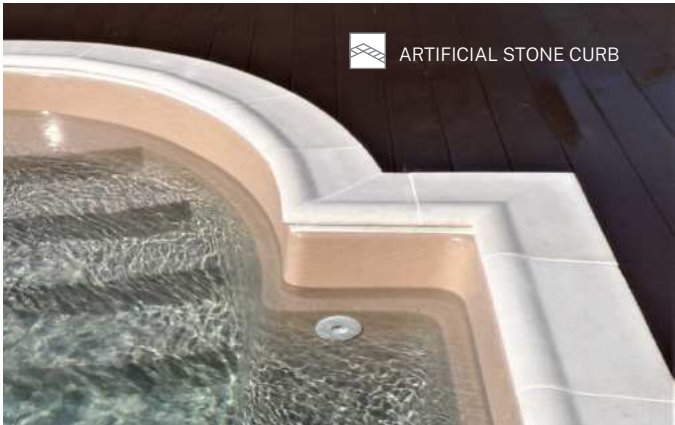

COVER

GRES COVER

The excellent quality of the gres tiles is due to the different manufacturing technology, which ensures that the tiles have outstanding wear resistance, extremely low porosity, and thus excellent frost resistance. It is also a good choice for endurance and increased use.

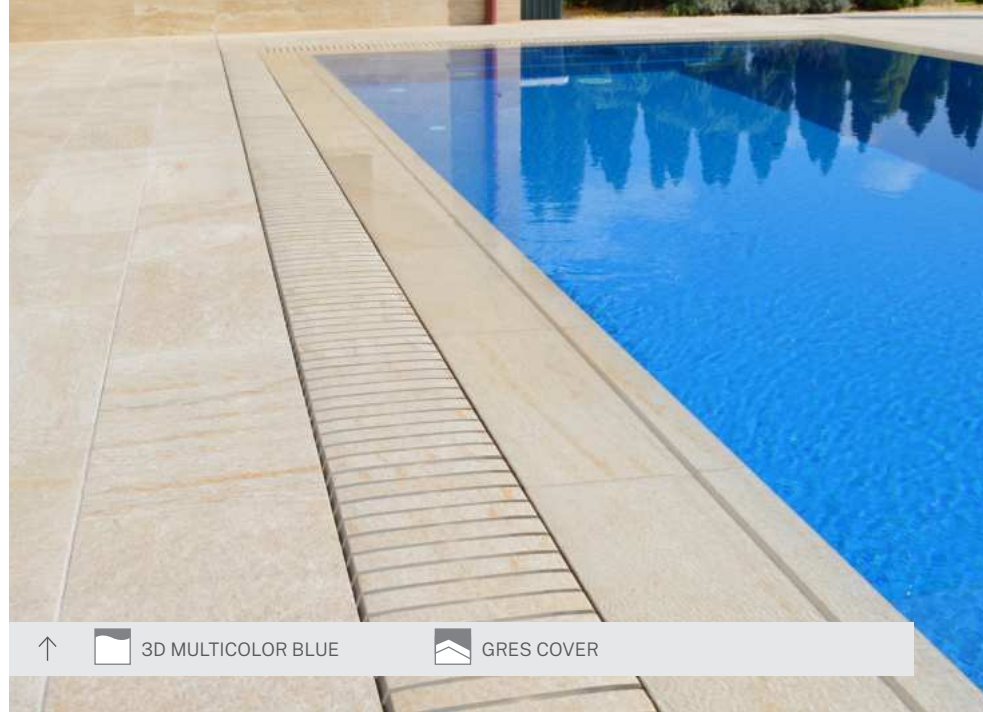

↑  GRES COVER

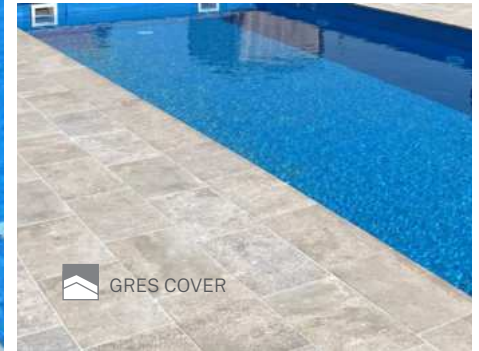

 GRES COVER

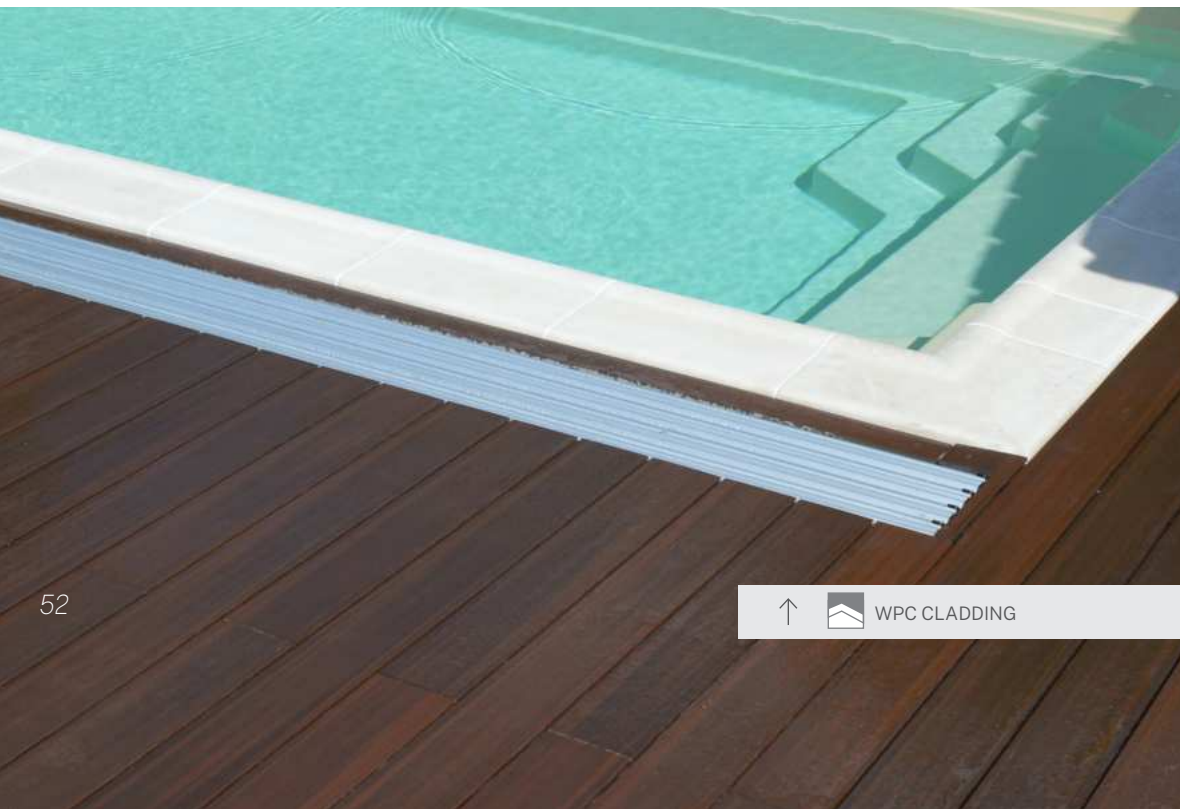

↑  WPC CLADDING

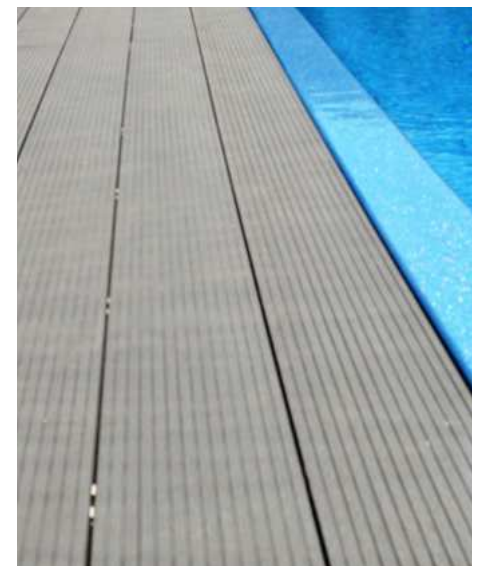

WPC (WOOD PLASTIC COMPOSITE) CLADDING

This cover does not lose its original beauty without surface treatment, and its components are almost fully natural or recycled materials, so it is environmentally friendly. It does not require increased maintenance, yet it retains its original beauty.

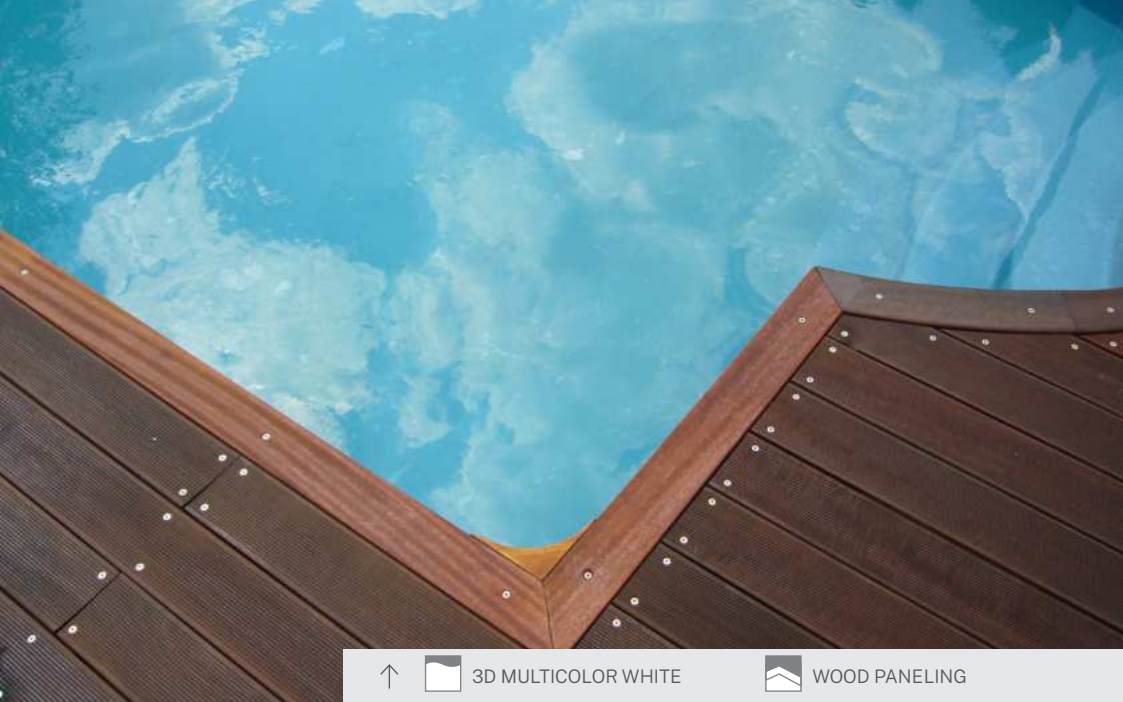

↑  WPC CLADDING



↑  3D MULTICOLOR WHITE  WOOD PANELING

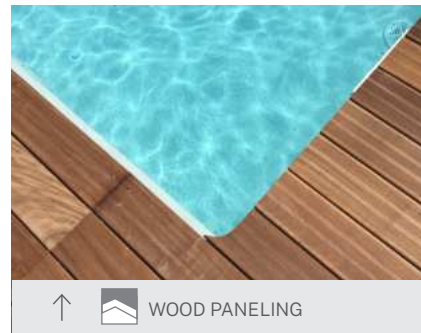

↑  WOOD PANELING

WOOD PANELING

Warm, natural cover. Exclusively made of hard or tropical wood, so it is water resistant, does not absorb water nor does it warp. Wood treatment is necessary at least once a year to maintain its appearance and increase its lifespan. We also provide consultancy and, if required, maintenance for the treatment of wooden finishes.

DECOR CONCRETE

Strong and durable, low-maintenance finish. It adheres well to any concrete layer used in construction and is therefore easy to install. Patterns and colors can be combined according to custom needs.

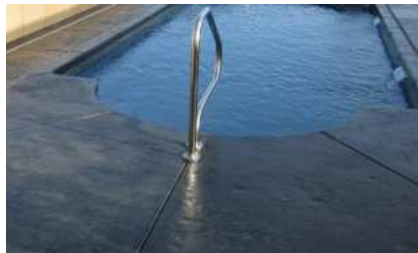

↑  DECOR CONCRETE



↑  DECOR CONCRETE



↑  DECOR CONCRETE

OUTDOOR FINISHES

Traditional ceramics, floor tiles - an infinitely variable solution for the design of swimming pools.



↑  GRANIT



↓  GRANIT

COMFORT & SUSTAINABILITY

INTELLIGENT WATER CLEANING

The intelligent cleaning system (IQ cleaning system) is a self-cleaning system with a complex distribution valve. The nozzle line at the bottom of the pool spreads the water, distributes the chemicals evenly, so cleaning is more efficient, effective, and convenient. The built-in distribution heads stir up the settled dirt and leaves so that they can be

removed through the built-in filter.

By stirring the hot water at the bottom, heating costs are also reduced, and the whole system is more sustainable. In addition, a special convenience feature is that the system can be programmed for automatic operation.

Because of water circulation

- no stagnant surfaces, which reduce the possibility of algae growth
- no chemical concentration near the water surface because of the even distribution
- and the water temperature is evenly spread, and mixing also makes better use of the solar energy

Overall, it makes bathing more comfortable!

↓ INTELLIGENT WATER CLEANING

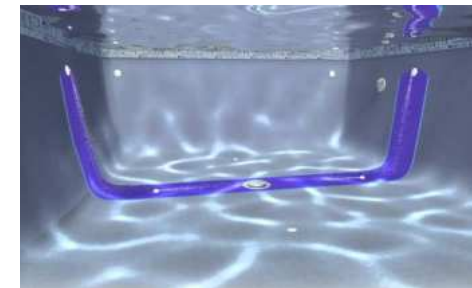
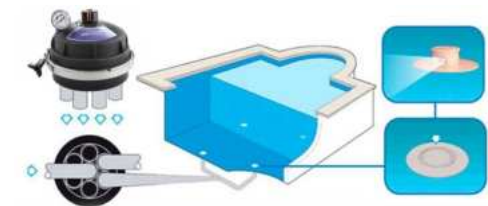

GREEN ENGINEERING – IRRITATION FREE

CHILD FRIENDLY SOLUTION

No itchy skin or reddened eyes - this is the biggest benefit of chemical-free cleaning, especially for young children.

Disinfection without the use of chemicals, crystal clear water. In addition to the therapeutic effects of mild salt water, bacteria-free water allows safe bathing. Beyond maintaining disinfection, it continuously recycles the dissolved salt, so it is more environment friendly.

- Expensive chemicals are replaced by cheap natural salt, which is enough to be replaced once a year
- Cost effective
- The use of a low-energy desalination device returns the investment in about 4 years

The principle of chemical-free cleaning is to add salt directly to the pool water at a rate of 4-6 grams per liter, which is approximately one-tenth of the seawater. The device decomposes the salt (sodium chloride) into chlorine gas by electrolysis, which has a very strong disinfectant effect and dissolves immediately in water. The active chlorine formed in the cells immediately destroys the microorganisms and provides a sufficient level of free chlorine even when diluted in the pool space. Active chlorine decomposes in the pool by the sun's UV radiation, but is automatically regenerated in the cell, creating a natural cycle.

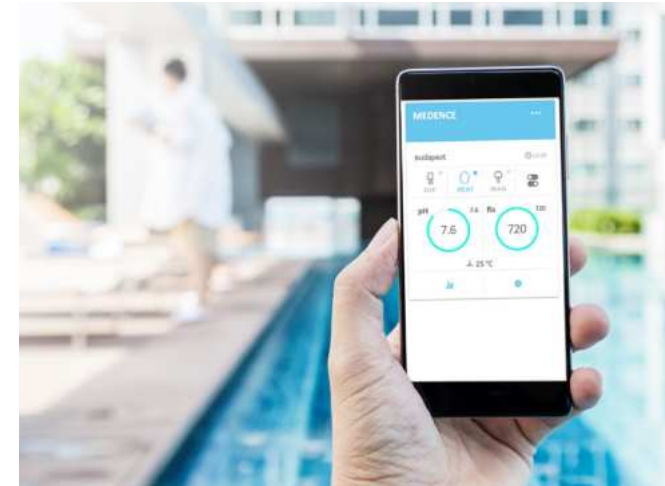
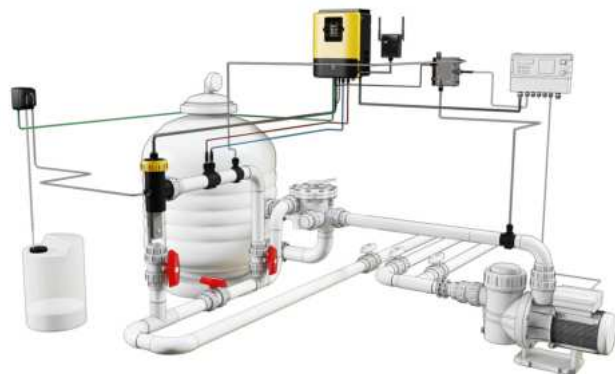

SPECTACLES & WELLNESS

Spectacle and wellness are essential to pools, and these accessories are available in our offer too.



· **UNDERWATER LIGHTING** -LED lights provide extravagant lighting that add a special glitter to the 3D multicolor of the AMPRON Cermaic System pools; digital remote control enables you to operate lighting from your mobile phone; electrical fittings are IP protected; lighting should be fitted upon installation



· **COUNTER CURRENT SYSTEM** –active relaxation is ensured by continuous, medium-paced current generated by the high-performance equipment built into the pool wall; for more active swimming the double or triple-headed equipment is recommended, which can be used by up to 2 people at the same time, depending on the size of the pool; the stepless power adjustment with air is unique; the equipment has a safety stop function; the electrical fittings are IP protected



· **HYDROMASSAGE, WELLNESS** –perfect massaging of muscles and joints is guaranteed by high-performance equipment



· **NECK SHOWER** – one of the most spectacular accessories for a pool; made of stainless steel, in various shapes and sizes; programable, can be operated with a pneumatic button; the most popular shape is the moon or cobra-shaped gargoyle; electrical fittings are IP protected





EFFICIENCY & COMFORT

LOW ENERGY CONSUMPTION

We offer four efficient and convenient pool heating modes with favorable low energy consumption. With digital control (see general pool engineering), you can conveniently adjust the pool temperature from the building or, being away from home, even from a mobile phone.



- **AIR SOURCE HEAT PUMP** –uses the heat of the ambient air to heat the pool; a highly energy efficient solution; keeps the pool temperature stable or re-cools it if necessary; it uses the pool's water circulation system, so water circulation doesn't come at an extra cost

- **ELECTRIC** -electric heating element 6-12 kW power, with temperature controller, timer, circulation pump control



- **SOLAR** –solar pool heating minimizes heating costs; the heat energy

produced by the solar collector enters the pool water through a heat exchanger by means of a circulating pump

- **HEAT EXCHANGER** -a nominal power of 25-60 kW depending on the size of the pool; can be used to supply thermal energy to the pool produced by a gas boiler, wood-fired boiler, fireplace, solar collector





CLEAN POOL

AMPRON pools are equipped with the most effective sand filter system to keep the pool water clean. With proper water circulation and treatment, the quality of pool water can remain usable for up to 4-5 years.

PARTS OF THE BUILT-IN WATER CIRCULATION SYSTEM WITH OPTIONAL ELEMENTS

- **FREQUENCY ENGINE** – based on energy saving and green technology



- **SAND FILTER TANK** – the most efficient water filtration; the filter tank contains a quartz sand filter cartridge, through which it filters the water returning to the pool

- **SIX-FUNCTION DIVERTER VALVE WITH DIGITAL DISPLAY** -

automatically backwash and rinse the sand filter tank



- **PH REGULATOR** -with the automatic pH measuring and regulating device it allows continuous adjustment according to the prescribed values; provides the most ideal use of chemicals

- **CHLORINE DOSING** -the device measures the chlorine and redox potential of water with probes; controls the amount of disinfectant chemical dispensed based on the measured data
- **DIGITAL CONTROL SYSTEM** -can be operated from a household circuit with remote control function; programable and controllable equipment and accessories belonging to and

surrounding the pool (lighting, filter system, irrigation system, cleaning equipment, etc.). The control unit can be connected to any socket inside the house and it communicates with the communication modules installed in front of the equipment via the existing network

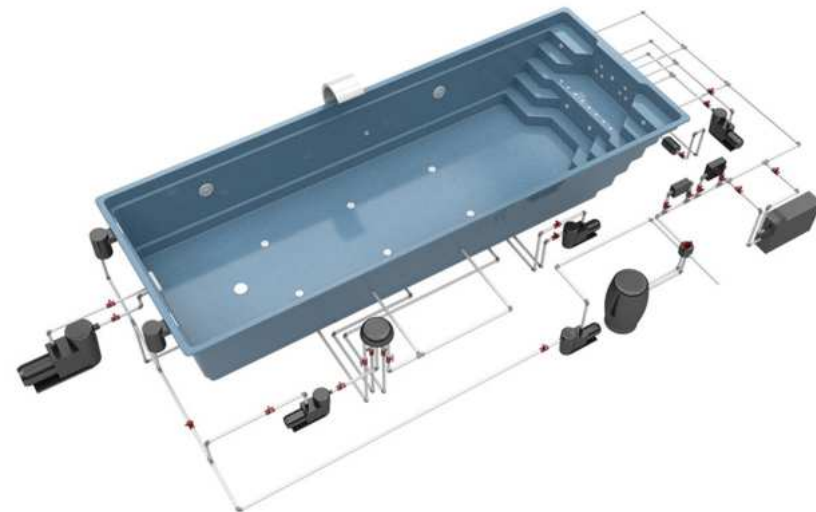

PREFABRICATED FIBERGLASS ENGINEERING SHAFTS

PRACTICALITY – SIMPLICITY - CLEANLINESS



SMALL TECHNOLOGY BOXES

Width	100 cm
Lenght	100 cm
Depth	90 cm

MEDIUM TECHNOLOGY BOXES

Width	150 cm
Lenght	120 cm
Depth	100 cm

BIG TECHNOLOGY BOX

Width	300 cm
Lenght	130 cm
Depth	100 cm

UNEARTHLY TECHNOLOGY BOX

Width	230 cm
Lenght	115 cm
Depth	110 cm

Mechanical equipment are integrated parts of any pools. AMPRON's proprietary prefabricated surface and subterranean fiberglass engineering shafts preserve the harmony of the pool environment, are easy to install and are practical.

THE SUBTERRANEAN ENGINEERING SHAFTS ARE

- can be pre-ordered with integrated engineering
- can be customized in 3 sizes
- can be installed quickly
- allow simple, easy access and operation of the equipment and keep clean
- the roof is available in the color of the pool tub





HIDDEN POOL COVERS

The AMPRON lamellar pool cover is available in a normal and a hidden version, in case of the latter one, the concealed cover hold in the pool tub hides the pool cover. The cover is driven by a motor mounted in a winding mechanism in a hidden location.

The opening and closing works with a safety switch. AMPRON covers can also be operated with digital or remote control.

When retracted, it can withstand normal human body weight.

The cover can also be equipped with solar panels, which raise the water temperature by 4-5 C compared to a normal lamella cover.



THE AMPRON LAMELLAR POOL COVER IS AVAILABLE IN A NORMAL AND A HIDDEN VERSION, IN CASE OF THE LATTER ONE, THE CONCEALED COVER HOLD IN THE POOL TUB HIDES THE POOL COVER. THE COVER IS DRIVEN BY A MOTOR MOUNTED IN A WINDING MECHANISM IN A HIDDEN LOCATION.

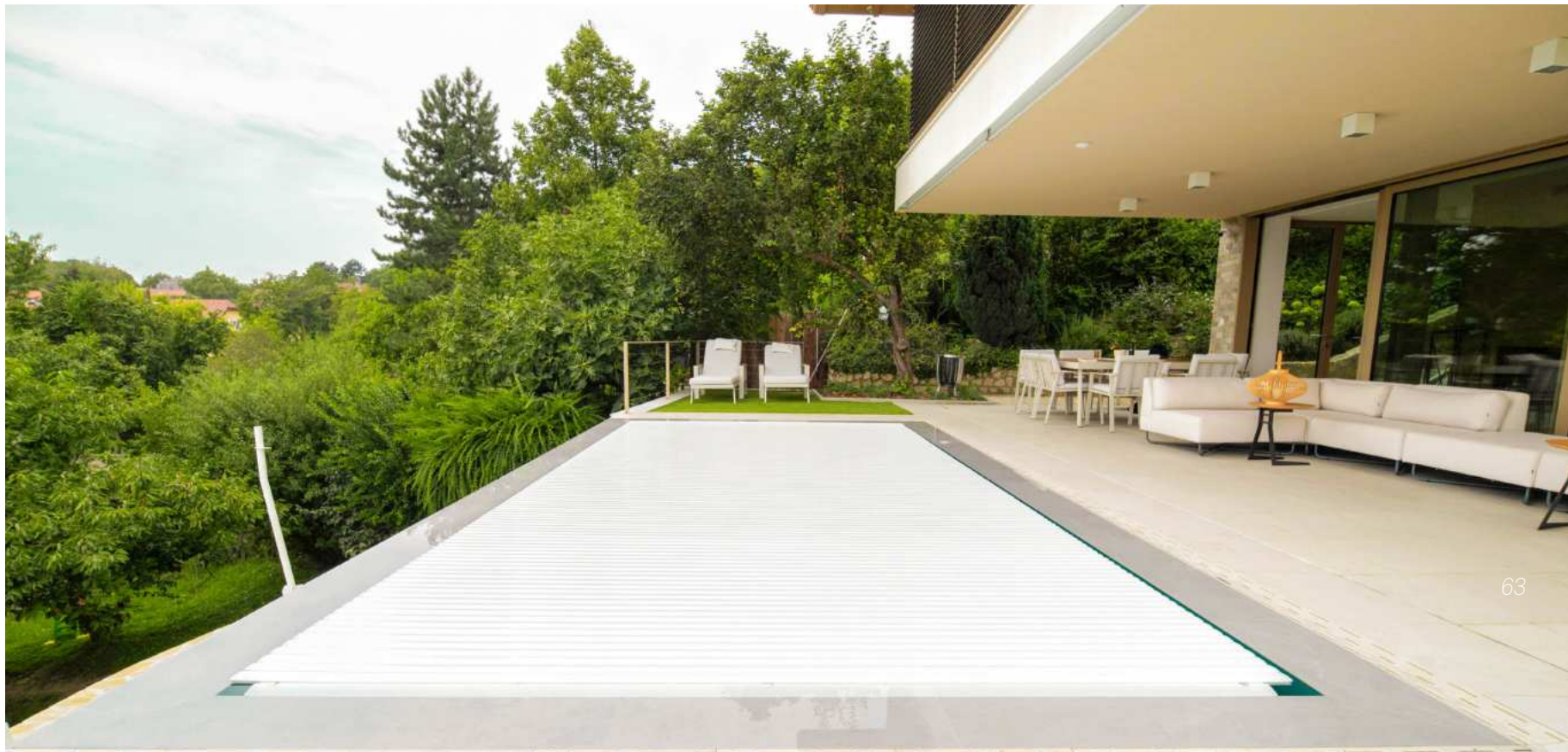

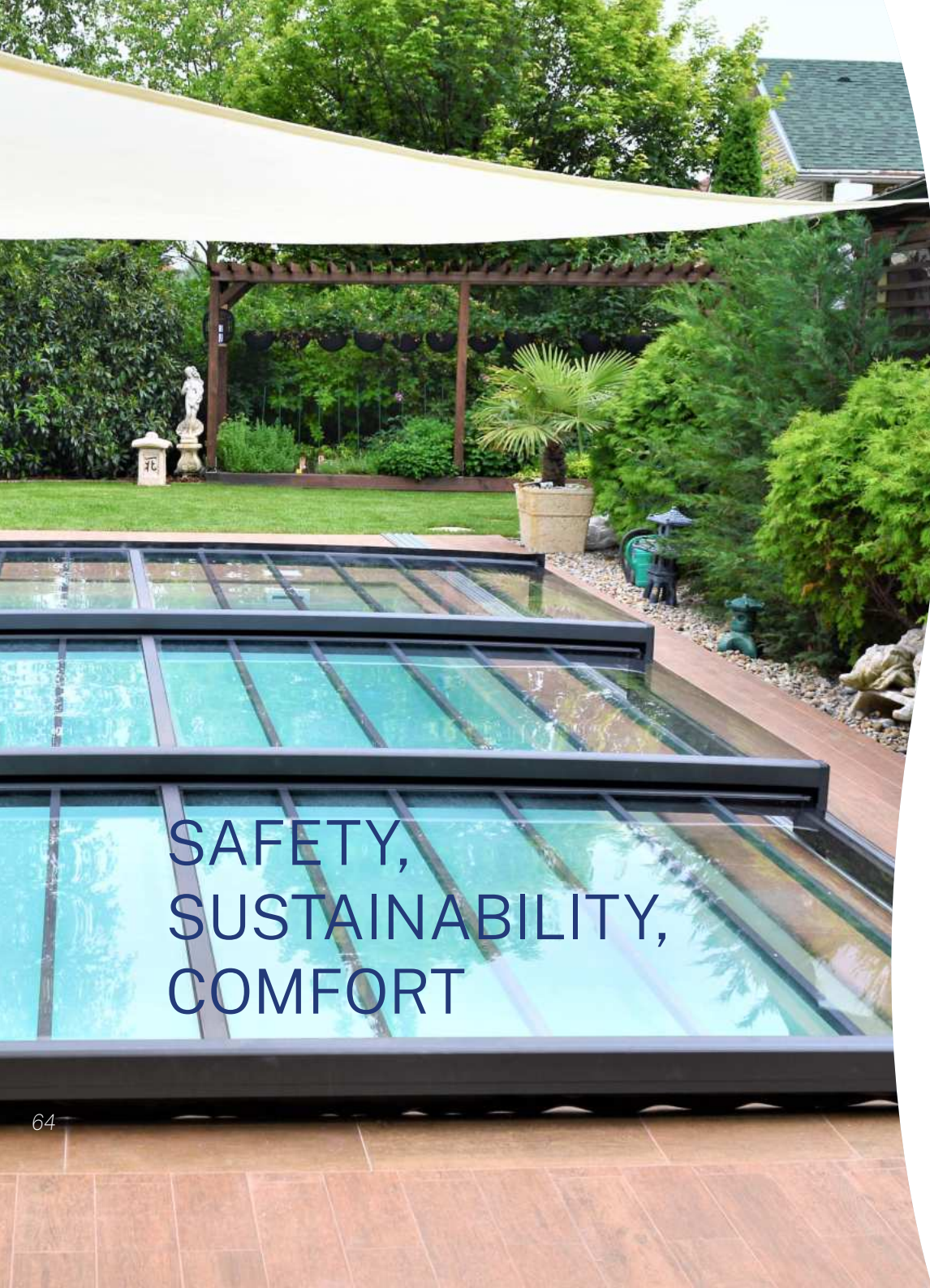

SAFETY,
SUSTAINABILITY,
COMFORT

COVERS

High, medium, and low covers are available for our pools to suit different needs

LOW COVER – advantageous in places where the panorama must be preserved

MEDIUM-HIGH COVER – if you want airier cover this solution is the perfect choice; it provides enough space to play in the water or relax on the shore, you can enjoy swimming in the pool even when the cover is on

HIGH COVER – the most spacious cover, if you want an outdoor pool to have almost all the comfort of an indoor one, then the high coverage is the right choice, and beyond that the mobility of the cover provides even more benefits, there is also enough space to relax on the bank of the pool

ACCESSORIALS – As an optional accessorial a regular or sliding door can be fitted into the largest segment

STRUCTURE – Frame profile natural anodized glazing. Depending on the cover type the structure can be

- 4 mm solid clear polycarbonate
- 4 or 10 mm air cell, clear polycarbonate

FASTENERS – Hidden system invisible from the outside, with chrome stainless steel screws

WHEELS – Extra strong plastic wheel with double stainless steel and water-resistant ball bearings

SLIDE TRACK – 13 or 15 mm low, convenient to walk on barefoot, super-flat anodized track

OPTIONAL – Openable front wall. Child protection segment lock system, unique segmentation, arc height increase, aluminum frame in unique RAL colors, motorized movement



LOW COVERS



ATLAS

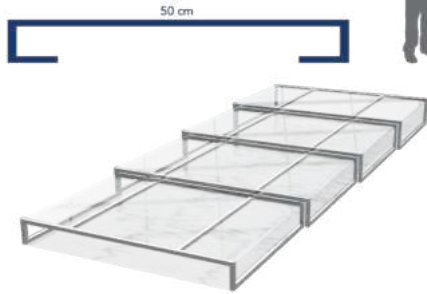

One of the lowest covers available, so it fits perfectly into any garden, not only highlighting the pool, but also allowing the beauty of the house and garden to prevail. A sophisticated combination of modern, flat and angular pool cover, a combination of comfort, aesthetics and user-friendly features. The stable but light structure of the sliding pool cover allows easy movement of all its elements. Transparent segments ensure a perfect view even when closed. The frame structure is made of a custom-made precious metal alloy. Rounded edges and corners prevent accidents. The safety catches protect the cover against accidental openings, closures and sudden gusts of wind. The operation is quick and easy. Average height: 50 cm.

MINERVA

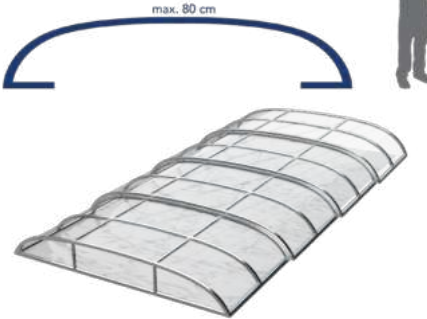

Low enclosure, elegant model, the right choice for those who put the harmonious view of their garden in the foreground. Compact, glass-like pool cover with a basket curve cross section and 10 mm air-cell polycarbonate glazing. Its standard rails, side entrance, high-quality insulating roofing material and removable front guarantee easy operation in all situations. The frame structure is made of a custom-made precious metal alloy. Rounded edges and corners prevent accidents. Average height: 70-80 cm.



MINERVA



VENUS

VESTA



min. 60 cm



Discreet and sophisticated low enclosure that stretches in any garden, what is best provided by its angular, clean roofing material, futuristic carbon design and low air rails. Average height: 60-70 cm.



VENUS



55 cm



Modern, super flat curved pool cover, without door, with 4 mm clear solid polycarbonate glazing. The frame structure is made of a custom-made precious metal alloy. Rounded edges and corners prevent accidents. Average height: 55 cm.

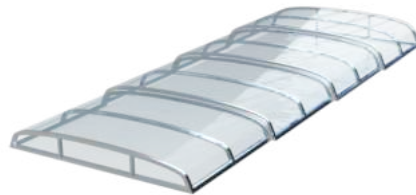

VESTA



LOW COVERS

MEDIUM HIGH COVERS

DIANA

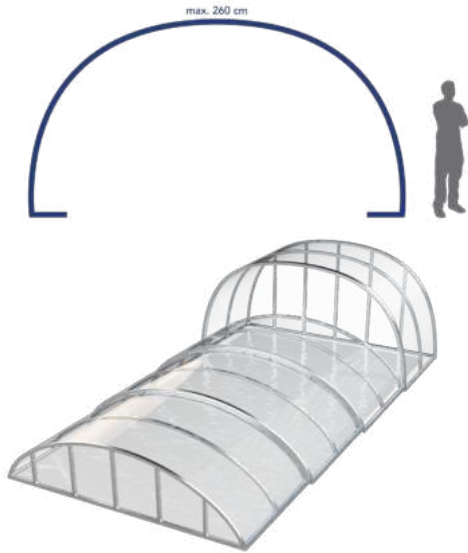

Basket curve cross-section pool cover with elevated foreground, medium-height additional segments, 10 mm air-cell polycarbonate glazing. The frame structure is made of a custom-made precious metal alloy. Rounded edges and corners prevent accidents. Average height: 220-260 cm.



DIANA



APOLLO

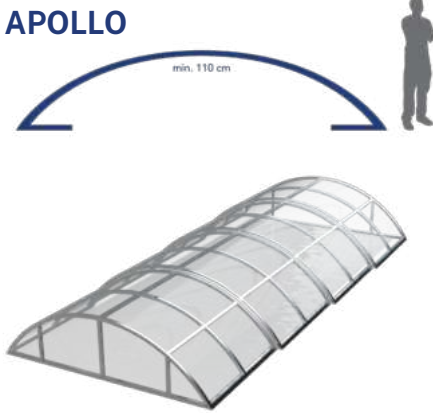

The Apollo is a classic model of mid-height pool enclosures that provides more freedom of movement under the enclosed pool cover. Circular pool cover with 10 mm air cell polycarbonate glazing. One of the most weather resistant covers. The frame structure is made of a custom-made precious metal alloy. Rounded edges and corners prevent accidents. Average height: 110-150 cm.



HIGH COVERS



AURORA

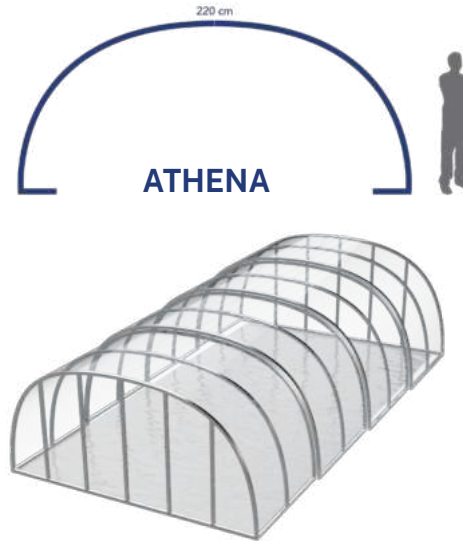

ATHENA

High basket curve cross-section pool enclosure with large interior space, 10 mm air-cell polycarbonate glazing. Increases pool usage features. The frame structure is made of a custom-made precious metal alloy. Rounded edges and corners prevent accidents.
Average height: 220-280 cm.



AURORA

Elevated asymmetrical pool enclosure, the shape of which was inspired by water droplets. It offers a great view in all situations and lends a charmingly elegant atmosphere to the pool. Made of 10 mm air-cell polycarbonate glazing. The frame structure is made of a custom-made precious metal alloy. Rounded edges and corners prevent accidents.
Average height: 220 cm.



ATHENA

FORTUNA

HIGH COVERS

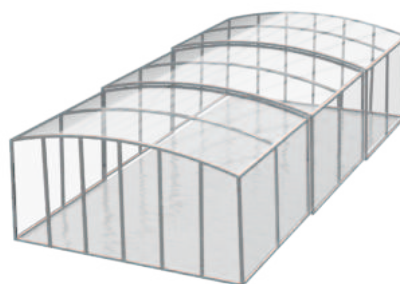

A twin-walled polycarbonate roof and a compact polycarbonate sidewall characterize this cover. The double-walled polycarbonate is 8 mm thick, the coverage is available in S, M and L profiles. The roof is extremely resistant and insulates very well, as well as providing UV protection. Average height: 220-280 cm.



QUALITY · RELAXATION · STYLE

IFK-AMPRON

H-2890 Tata, Déli Ipari Park 460/217

Tel: +36 34 379 171

Email: info@ampron.hu

Follow us on social media!

